

DEKBOARD[®]

Wood Polymer
Composite Decking
Installation Guide

Excellent for homes.
Ideal for commercial spaces.

DEKBOARD

Wood Polymer Composite Decking

Using the tried and tested benefits of DekBoard Wood Polymer Composite deck boards we have perfected an attractive wood grain effect outdoor board that will look and feel like a timber board, to go alongside our grooved and ribbed range. With face fixing screws, it is even fitted like a timber board.

Now you have decided on DekBoard it is time to install your deck.

If you want to install your own deck, please follow the installation instructions on the following pages. Please pay special attention to gaps, spaces and tolerances indicated in this guide, as this will keep your deck in top condition and perform for years to come allowing you to enjoy your outdoor space with your friends, and family.

We hope this installation guide helps with any install questions you may have. If you have any difficulties, then please email sales@dekboard.co.uk



DEKBOARD

The DekBoard System

No specialist tools are required to install DekBoard, however we would recommend the following tools which will help you install your perfect deck.



Circular Saw



Cordless Drill



Spirit Level



Smart Bit



Chalk Line



DekBoard Spacer



Safety Glasses



Hearing Protection



Dusk Mask

BUTT JOINTS

- When fitting butt joints, you must always use double bearers for support
- Spacing at butt joints must be 5mm or over. Screws should be no closer than 20mm and no further than 40mm from the edges of the boards
- If butt joints are cut at an angle, ensure they are secured well
- Ensure butt joints are left clean and free from debris after installing.

Mitre detail suggestion:

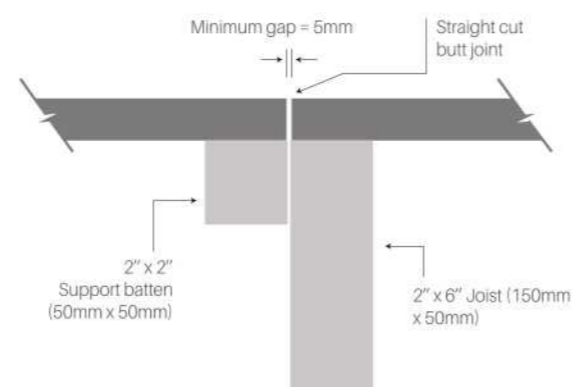
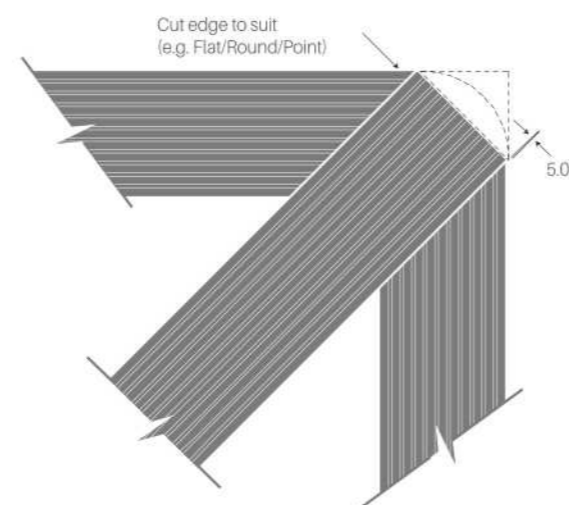

Note:
A double joist can be used here if preferred. Either way the joists and/or support batten should be bolted together with an M10 coach bolt and nut.

Screws and Placement

53mm and 63mm Screw Usage

PRODUCTS	Wood	Low Profile/ Superstiff Composite
DekBoard Reversible	53mm	53mm
DekBoard Woodgrain	53mm	53mm
DekBoard Essentials	53mm	53mm

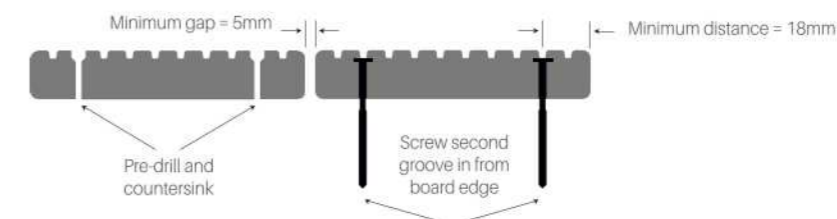

- Use an 18 v or above cordless drill/Impact driver
- All screw holes must be predrilled using a smart bit
- Screws must be placed in the 2nd groove for the Dekboard Reversible/DekBoard Essential boards, or 18mm from the board edge for the Dekboard Woodgrain range
- 2 screws must be used opposite each other on each bearer.
- Screws must not be fitted in a zigzag formation.
- When driving the screw home, pressure must be placed on the top of the drill until the screw is fully driven home.
- When removing screws, ensure you keep the drill bit fully engaged in the screw head with downward pressures applied at all times whilst removing the screw.
- Never place or fix screws without pre-drilling.
- Fascia must be screwed down at 200mm screw centres.
- When building a composite-to-composite structure, pilot holes of 3.5mm diameter and at least 90% of the depth of the screw must be used. Composite is a very tough materials and the screws may shear if the pilot hole is not deep or wide enough.
- Only use approved DekBoard composite screws

BOARD SPACING / GAPS

- The gap along the length of the boards must be a minimum of 5mm (increase this to 10mm for hot, humid, damp or poorly ventilated areas).
 - Gaps at the ends of the boards up against a hard surface such as a fence, wall, sleepers, lawns etc, must be a minimum of 10mm or more to allow for good air circulation.
 - Gaps at butt joints must be a minimum of 5mm or more.
 - Steps & Fascia: Gaps on steps and fascia must also be fitted to the same standard as DekBoard deck boards. Air gaps and ventilation are essential to the longevity of the installation and the boards themselves. Fascia must also be screwed down at 200mm centres.
 - Use a 5mm spacer to ensure all gaps are even and boards are kept straight.



AIRFLOW

- DekBoard boards should have at least 80mm ground clearance to allow for good airflow and ventilation under and through the decked area.
- All bearers should be lifted up to allow drainage and airflow underneath the bearers. Please note that low profile bearers need supporting every 500mm, Superstiff bearers need supporting every 1000mm. (use surface vents to improve airflow if necessary - see examples below)
- If fitted as a sunken deck, it is recommended air vents are installed to aid airflow under the deck. These vents can be fitted at the edges of the decked area and usually up against the house or retaining wall.
- If steps are being fitted to a decked area it is good practice to install air vents/grills on the riser. These can be bought as ornamental fittings and will act to enhance the decks appearance as well as the practical side of aiding airflow and ventilation.
- If fascia is used on the side of a raised deck, a gap of 5mm or more must be left between the boards.
- If a brick structure is built to support the deck. Vents must be integrated into the structure to allow adequate ventilation.

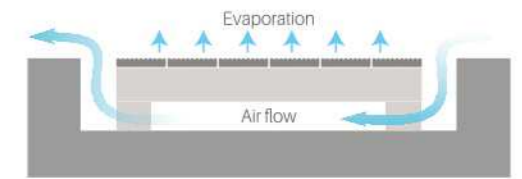

Suggested air vents

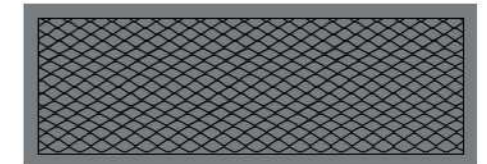
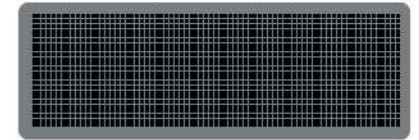

CLEANING AFTER INSTALLION

- After the deck has been installed it is important to clean the surface of the decked area.
- If the decked area is left uncleaned, it can leave the surface slippery creating a potential hazard.
- Only clean the surface with approved cleaning solutions. Never use harsh chemicals or a jet wash as these may damage the appearance of the board's surface appearance which will be difficult to restore.

Scuffs and Scratches

If scuffing does occur, please follow the options below.

- Firstly, leave well alone. Once the boards have weathered over the course of a few months the scuff marks will naturally disappear and become unnoticeable.
- If the scratches or scuffs are a little deeper but not fully through the top surface, a walnut can be used to help blend the marks until weathering has taken place.

ONLY A NATURAL RAW WALNUT SHOULD BE USED....
DO NOT USE EXTRACTED WALNUT OIL
OR ANY OTHER OIL USED FOR SCRATCH REMOVAL



Gently rub the flesh of the walnut over the affected area and allow the natural oil soak into the scratch.

Try not to get the oil over too large an area as it will make the surface extremely slippery. Highlight that oil has been applied and it will fully weather off in a few weeks after which time the scratches will be almost unnoticeable (it can be re-applied if needed without causing any issues/damage to the board)

- If the boards have serious gouges in them, contact us for a possible replacement.

TOOLS REQUIRED

Dekboard Reversible / DekBoard Woodgrain /Essentials Boards:

- Support frame (substructure) joists must be spaced at centres of 455mm (18 inches) Dekboard Woodgrain and Dekboard Reversible / 350mm (14 inches) Essential or less for residential decks.
- When laying timbers at 45°, support joists must be on centres of 330mm (13 inches) Dekboard Woodgrain and Dekboard Reversible / 255mm (12 inches) Essential or less.

Important Notes:

- In all cases, boards must not overhang joists by more than 40mm.
- When boards are butted up together (Butt joints) a full-length double bearer must be used to support the boards. When butting up please ensure there is a minimum gap of 5mm.
- All boards MUST span a minimum of three bearers (No matter the length of board)



Support/Substructure Materials

There are many materials that can be used for a supporting substructure. We recommend the following to ensure top performance and longevity:

- DekBoard 38mm x 88mm Superstiff Bearer (need supporting every 1000mm)
- DekBoard 40mm x 48mm Low Profile Bearer (need supporting every 500mm)
- C16 or C24 graded 6"x 2" treated softwood.

Please note: DekBoard will need more support than softwood. Therefore, it is important to refer to the technical data on our website at www.dekboard.co.uk

TRADITIONAL SUBSTRUCTURE

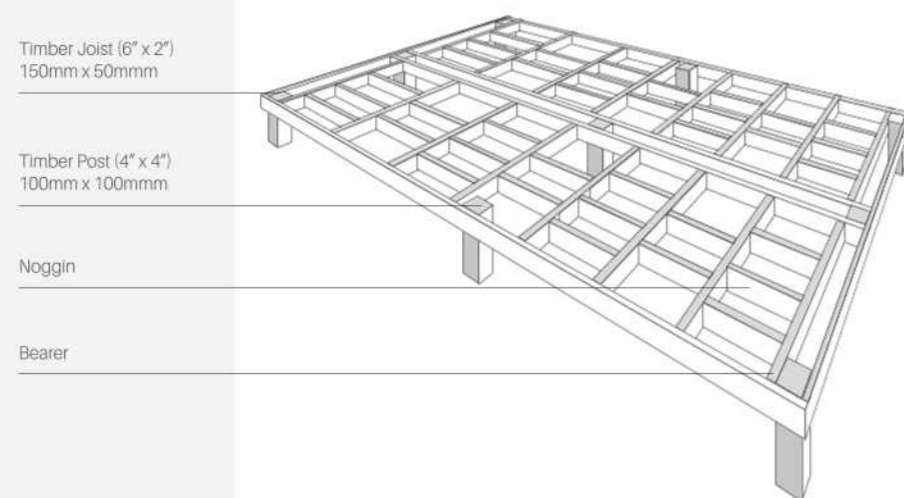

- Requires 4 corner posts cemented at least 300mm into the ground
- Requires additional posts every 1500mm (including in the centre)
- Attach joists to create a frame.
- Attach bearers.
- Requires noggins to prevent the frame from twisting
- Lay boards in the opposite direction to bearers
- Ensure substructure does not restrict airflow.



PEDESTALS ON CONCRETE

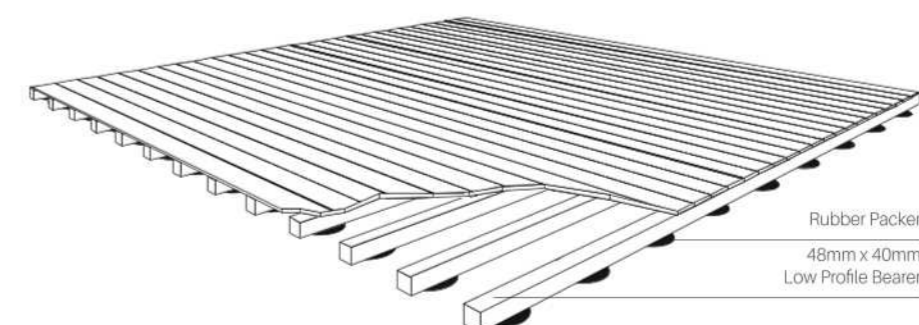

- Rubber packers (or similar) should always be used to hold the bearers off the concrete surface to allow sufficient drainage. (DekBoard must never be placed on the ground without speaking to our technical department first). The lowest workable height is 101mm = 21mm deckboard + 48mm bearer + 32mm pedestal/packer.
- Do not use substructure thinner than 38mm as there will not be enough depth in which to put the short (53mm) composite deck screws (do not use any other type of screw without consulting DekBoard first).
- The bearers should run in the direction that will allow the most airflow under the decking.
- Always pre-drill to 100% of the screw depth with a 3.5mm bit when screwing composite to composite.
- Never clad the sides of the deck as it is important to maintain good airflow. (If you intend to us cladding/fascia on the sides of the decked area, ensure a minimum gap of 5mm must left between the boards and air vents are fitted to the face of the clad ding/fascia to allow for good airflow/movement under the decked area).
- If you have a recessed area where airflow is limited or need to work outside the specification for any other reason, please speak to the DekBoard Technical Department

BALCONIES AND TERRACES

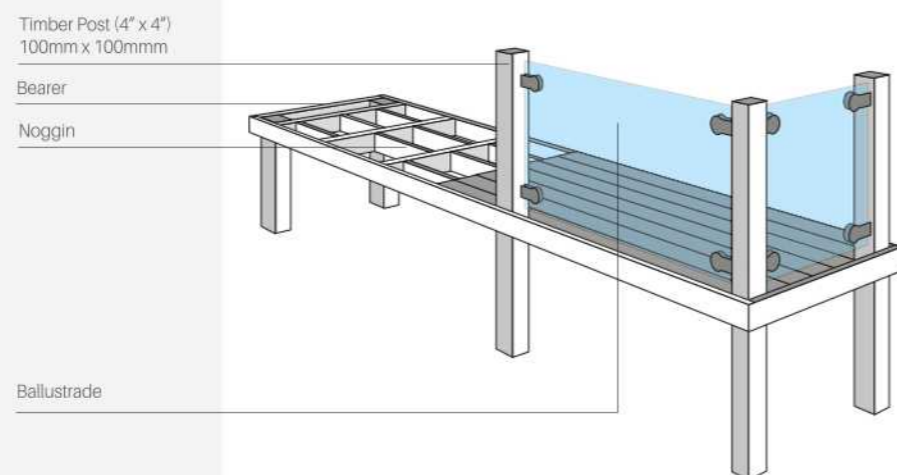

- Attach main joist to the building and install posts in each corner. Requires additional posts every 1500mm in the centre of the outward facing section of the frame.
- Attach joists to create a frame
- Attach bearers.
- Requires noggins to prevent the frame from twisting
- Lay boards in the opposite direction to bearers. N.B: Requires a balustrade that is at least 1100mm high. If not using a glass option, the bars of the railing and the bottom rail should be no more than 99mm apart; an object of 100mm diameter should not be able to pass through.

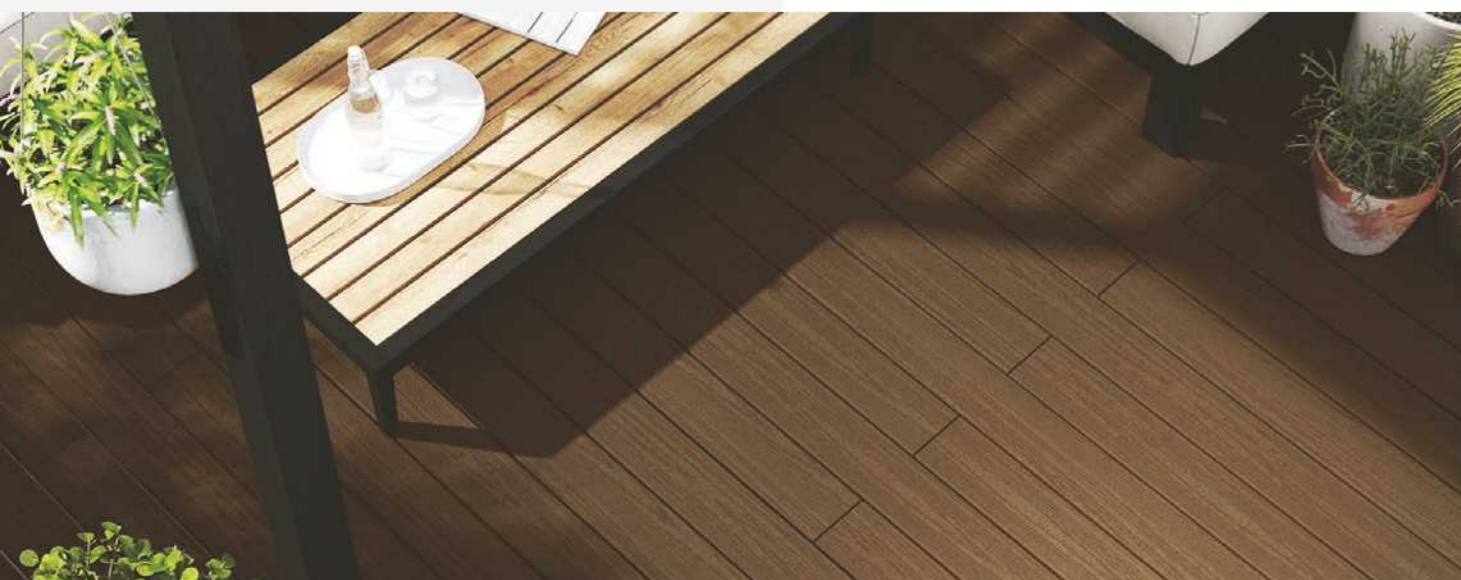

Step Details

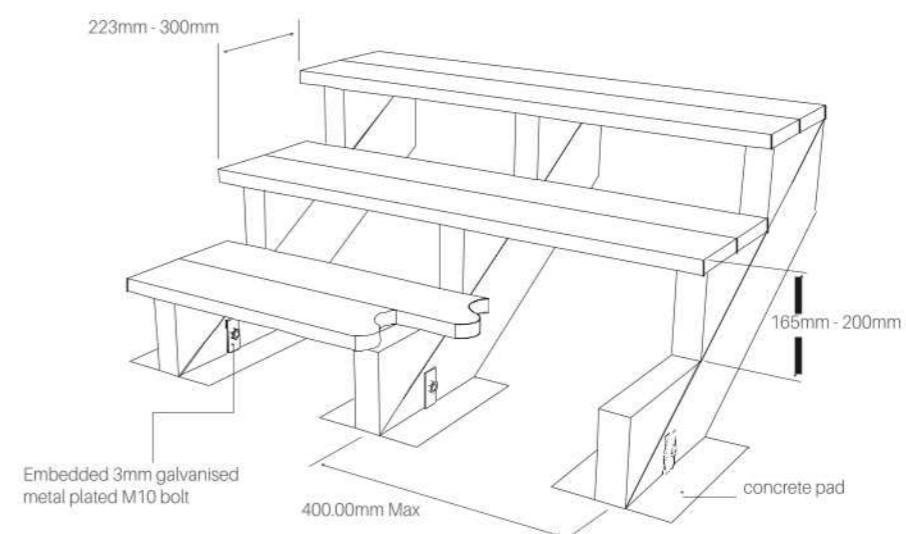

- You can use DekBoard deck boards 2-up to make the step surface (also known as the 'going').
- If you butt the boards together, then you will achieve a total 'going' of 276mm (total 'going' allowed is 223mm - 300mm).
- The 'nosing' or overhanging front lip of the step must be at least 16mm. The difference in height between 2 consecutive steps (also known as the 'rise') must be between 165mm and 200mm in this situation.
- Ensure bearer spacing is 400mm max, 2 screws per board, per bearer. Step sub-frame should be securely anchored to the ground, preferably on concrete footings.



SERVICE/ ACCESS HATCH

- When building a service access hatch, it must take the form of a cross window frame design to ensure the board are held solid on every plane.
- Do not build the hatch using just three supports across the boards.
- Make a frame around the edge of the boards joining at each corner. Then inside the frame insert and secure the cross members.
- Ensure all frame sections are secure and unable to move along any plane before use.

Things Not to Do

- Do not lay boards directly onto a non-self-draining surface without consulting our technical department team first.
- Do not use hidden fixings or clips.
- Do not butt up boards end to end closer than the specified amount.
- Do not work to a lower height threshold than an 80mm cavity under the deckboard.
- Do not clean DekBoard boards with a jet wash.
- Do not clean the surface of the deck with any solutions containing Bleach or Chlorine.
- Do not install DekBoard posts over 1.2m without a 2" metal scaffold pole insert.
- Do not place DekBoard boards on gravel or any other abrasive surfaces while storing ready for use. This may scratch or scuff the surface.
- Do not fit butted up boards onto a single bearer.
- Do not ignore the ventilation requirements for DekBoard. Please read the supplied instructions
- Do not ignore the spacing/screwing instructions. Please read the supplied instructions.
- Do not sand the surface of the boards.

AFTERCARE: CARE & MAINTENANCE

To keep your DekBoard in tip top condition we advise you use our recommended (WPC) Wood Polymer Deck cleaner at least twice a year (More in heavy use areas or areas subjected to high levels of contamination).

Important Points:

- Ensure ventilation underneath boards and required spacing between boards is maintained.
- Keep debris out of gaps between boards.
- Avoid any contact between boards and construction materials such as plaster, masonry, gravel, cement, and organic materials during construction and after.
- Recommended mould cleaners may be used as directed.
- All heavy items should be placed over joists to minimise the possibility of sag on the boards.
- DO NOT USE JET WASHERS

Cleaning:

- Remove all furniture and other items from decked area.
- Sweep the decking removing all leaves and other debris.
- Clean all debris from gaps between boards to allow for proper drainage.
- Make up the cleaning solution as directed on the bottle and apply to the surface of the deck using a soft mop (or very soft nylon bristle brush) and gently work into the surface. Allow the solution to sit for 15 - 20 minutes.
- Go over the surface again with any remaining solution and immediately rinse off the solution using a garden hosepipe ensuring all the solution is removed.
- Do not be tempted to use jet wash. Using our recommended WPC cleaner and a common garden hose is more than enough to clean and restore your DekBoard and you may risk damaging the deck surface due to the high pressure some jet wash machines can produce.
- Let the decking dry fully before putting any furniture and other accessories back.

If you discover any difficult to remove stains, please contact our Technical Department for advice on how best to remove it. Please do not use a jet wash or harsh chemicals as they may cause damage to the surface. If you see dark spots on the surface of the deck, it may be the start of a mould/fungal infection. It is very important you apply an anti-fungal solution to the surface immediately to prevent any infection spreading.

Anti-fungal deck/ patio washes are readily available from any DIY store; however, we do recommend Simply Gone and Wet and Forget. For best results please follow the manufacturer's instructions.

While applying, please keep young children and pets away from the area that is being treated. Once the solution has dried the area will be safe to use as normal including after rainfall or washing of the surface.

Simply Gone or any other anti-fungal washes are harmful to aquatic life and must not be allowed to enter ponds and any other water system. Be kind to the environment and store any remaining solution until needed.

Snow/Ice: If the winter weather has left your decking slippery or ice covered use sodium chloride (table salt) to remove the snow/ice.

Flowerpots/Plants: Flowerpots can create potential problems with staining when sitting directly on the deck. Minerals from the soil and fertiliser can end up leaving a white discolouration on the deck. We recommend using a plant stand to elevate and enable air flow underneath.

Furniture: All items regularly left on the decking can impact on the weathering that the boards received. We recommend that all items of furniture are regularly moved to allow for more evenly distributed weathering. DekBoard is an inherently low maintenance product if you follow the above advice and will give you many years of service. If any DekBoard boards become damaged from heavy impact they will need to be replaced with a spare. If a board should become scratched, gouged, chipped please contact the Quality Department direct on 01978 667 840 or customer@DekBoard.co.uk for advice on how best to repair the damage.

If you have any questions or concerns regarding DekBoard, please contact us direct and we will be more than happy to discuss them with you.

For full care and maintenance instructions, please visit our website www.DekBoard.co.uk



DEKBOARD®

Billet Lane
Normanby Enterprise Park
Normanby Road
Scunthorpe
North Lincolnshire
DN15 9YH

01724 848500
sales@dekboard.co.uk

dekboard.co.uk



Due to the limitations of the printing process the swatches and photography in this brochure should be taken as a guide and not an accurate representation of the actual product colour.