

DEKBOARD[®]

Installation Guide for Leisure Sector

The official installation guide for
DekBoard's Authorised Installer Network

Welcome to the DekBoard Authorised Installer Scheme

We're delighted to have you on board!

The installer scheme becomes a partnership between DekBoard and the installer, where the installer agrees to work to these aligned techniques and values on their installations.

The techniques detailed in this booklet will help you to install decks which match the requirements of our national contracts and ensure that you meet our high standards of quality, service and aftersales.

Health & Safety - Training Recommendations

All of our Authorised Installers are required to carry out regular health and safety awareness training, for example:

- Health and Safety at Work
- Manual Handling
- Driver Assessments
- Driving with a Trailer
- Abrasive Wheels
- First Aid
- Lone Working
- Working with Power Tools
- Safe Lifting

Liability

- Minimum £10m Public Liability Insurance
- Suitable Employee Insurance
- PAT cert electrical equipment

Toolbox

- First Aid Box
- Ear Defenders
- Man at Work Sign
- Chop Saw
- Skill Saw
- Jigsaw
- Cordless Drill
- SDS Drill
- Angle Grinder
- 6ft Level
- 4ft Level
- 3ft Level
- 16a Adaptor for Caravan
- 32a Adaptor for Caravan
- 240v 50m Extension Leads
- 240v 25m Extension Leads
- Breaker
- Turf Cutter (Optional)
- Shovels
- Squares
- Sliding Bevel
- Chalk Line
- String Line
- Hammer
- White Mallets
- Quick Clamps
- 25mm Hole Saw
- 13mm Socket
- 19mm Socket
- Large Axle Stands
- Medium Axle Stands
- Small Axle Stands

Installation

Care should be taken when working in extreme windy and wet conditions. All Installations should take place at ambient temperatures between 5°C and 25°C.

Solvent adhesive or superglues must never come into contact /be used with foil surfaces. All products must be stored out of direct sunlight.

Note: Glass screens are known to intensify the effects of sunlight on plastic packaged items.

DekBoard Non-stock Items

- C16 or C24 50x150mm nominal timbers for subframe
- C16 or C24 95 x 95mm nominal timbers for posts with 20 x 20mm notch out for cables if fitting lights
- Paving slabs
- Sand and cement
- Membrane
- Lights/cabling
- Steel L clips for securing starter boards
- T Star Washer Head Screws for steps
- Self tapping screws for reinforcement bar
- Ramp base plate
- Low Modulus silicone for post caps

- Welcome **2**
- General, H&S, Insurance & Toolbox **2**
- The DekBoard System **4**
- Component List **4**
- Building the Subframe **6**
- Positioning the Subframe **8**
- Badging **8**
- Tying to the Caravan **9**
- Steps **10**
- Ramps **11**
- Laying Deck Boards **12**
- Balustrade **14**
- Fascia and Skirting **16**
- Gates **18**
- Post Lights **19**
- Key Dimensions **20**
- Fixing Summary **22**
- Finishing Touches **24**
- Maintenance & Aftercare **25**
- Specifications and Convention Tables **26**
- Test Reports **28**
- Guarantee **30**



The DekBoard System



Deck Board
145mm and 195mm wide boards



Post Sleeve 32mm Square Picket



Post Cap Post Skirt



Top Rail - Plain and Routed Bottom Rail - Plain and Routed 150mm x 25mm Picket or Fascia Board for Skirting

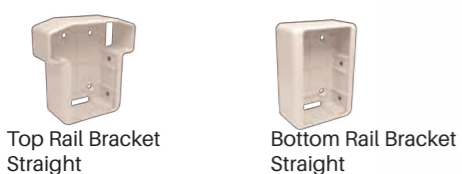

Top Rail Bracket Straight Bottom Rail Bracket Straight



Top Rail Stair Bracket Kit 30° 1 x up 1 x down Bottom Rail Stair Bracket Kit 30° 1 x up 1 x down

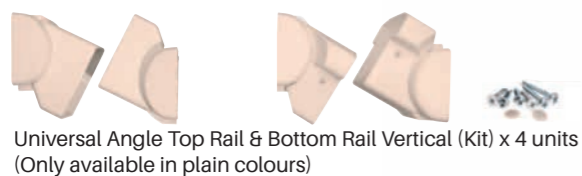

Universal Angle Top Rail & Bottom Rail Vertical (Kit) x 4 units (Only available in plain colours)



Universal Angle Top Rail & Bottom Rail Horizontal (Kit) x 4 units (Only available in plain colours)



Welded Gate (hardware inc fixing screws sold separately)

Foot Block

Rail Reinforcement

Ramp Post Mount

Latch

Hinges (set of 2)

Subframe Bracket

Infill Trim

D Trim

Deck Joint

Edge Trim

Angle Trim

U-Channel

Fixings (See page 28 for use)

Deck Clip

L Bracket

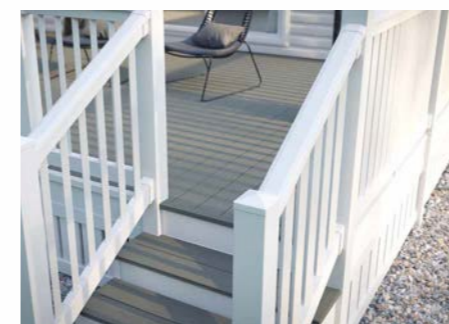

note: two step handrail options available; pickets and no pickets

Building the Subframe

Components

Build frames using nominal 150mm x 50mm timber (6" x 2"), at least C16 in quality (C24 recommended).

Timbers max length 2220mm. Use DekBoard subframe bracket in each corner.

Posts should be 95mm x 95mm at least C16 in quality (C24 recommended) timbers with 20 x 20mm notch out for cables if lights are being fitted.

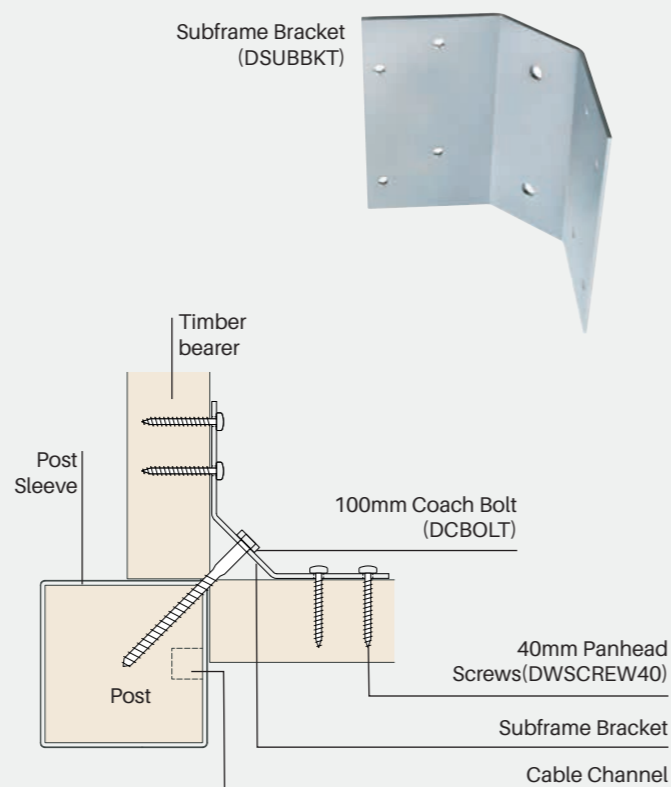

Note Consideration must be given to the position of the cable channel with regard to fixing screws.

Subframe bracket Fixing	Fixings
Subframe bracket to post	2 x 100mm Coach Bolt
Subframe bracket to subframe	8 x 40mm Panhead Screws

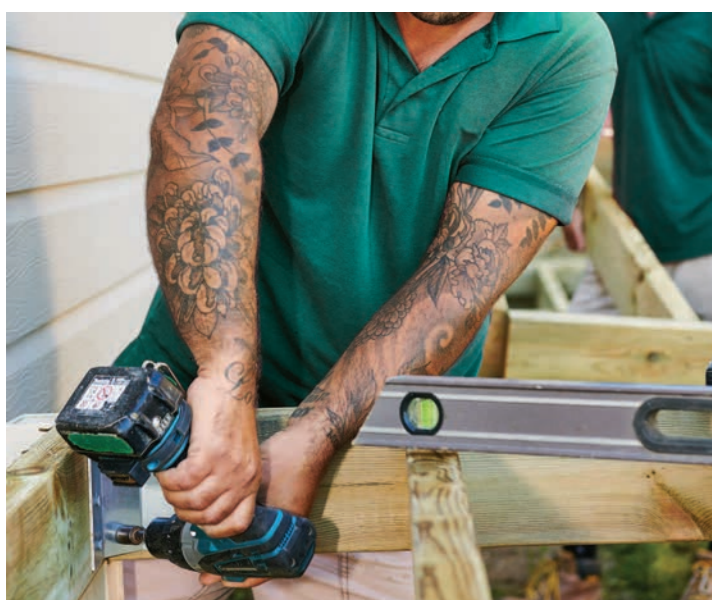

Dimensions of subframe and steps

All dims are edge to edge.

Allow for 120mm gap around caravan from inner subframe face to caravan/ lodge side.

Max unsupported length or width between posts of 2220mm

Joist centres must not exceed 400mm.

When measuring the caravan side, ensure there is a gap of at least 700mm between back of last post and caravan door retaining clip.

Steps are fitted at 30° gradient.

See detail on pages 10.

Typical installations may include side decks, front decks, ramps and full wrap around decks. The sizes and exact layout will vary depending on the park's own rules and requirements.

Example of a side deck

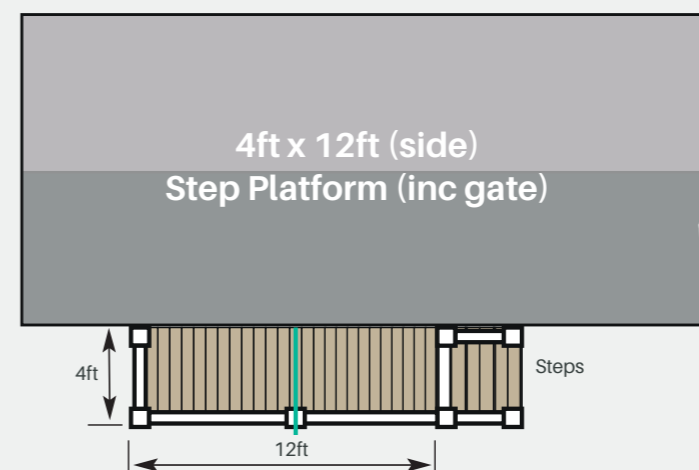

TIP Line up balcony corner in line with caravan / lodge corner, no over hang.

Example of a wrap around deck

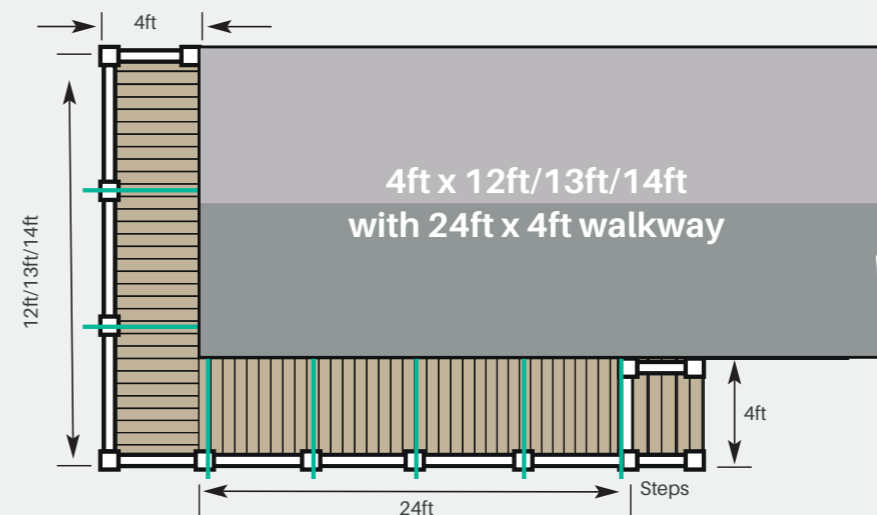

TIP Check alignment of Posts using a plumb-line.

TIP Walkway end point, take consideration for door opening and latch, low level windows to avoid gate interference.

Key — = Subframe Joints

Positioning the Subframe

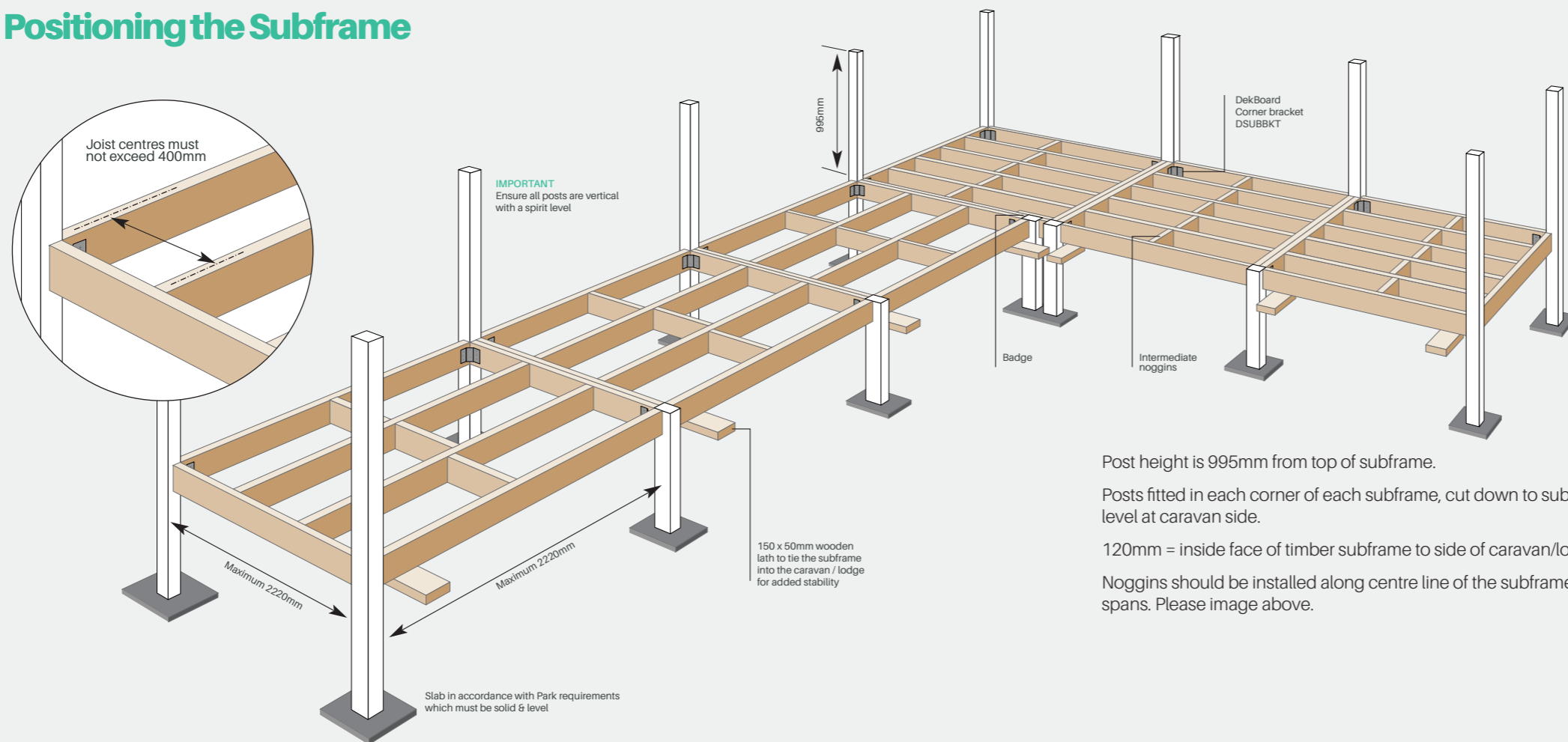

Post height is 995mm from top of subframe.

Posts fitted in each corner of each subframe, cut down to subframe level at caravan side.

120mm = inside face of timber subframe to side of caravan/lodge.

Noggins should be installed along centre line of the subframe spans. Please image above.

SUBFRAME

dekboard.co.uk

Badging

Notching out along the bearer

Use the BADGE system when notching out side of frame for additional posts. Cut out the required space and reinforce from the rear with a piece of timber.

Steps badges are made externally and inserted into the frame.

Positioning of ties

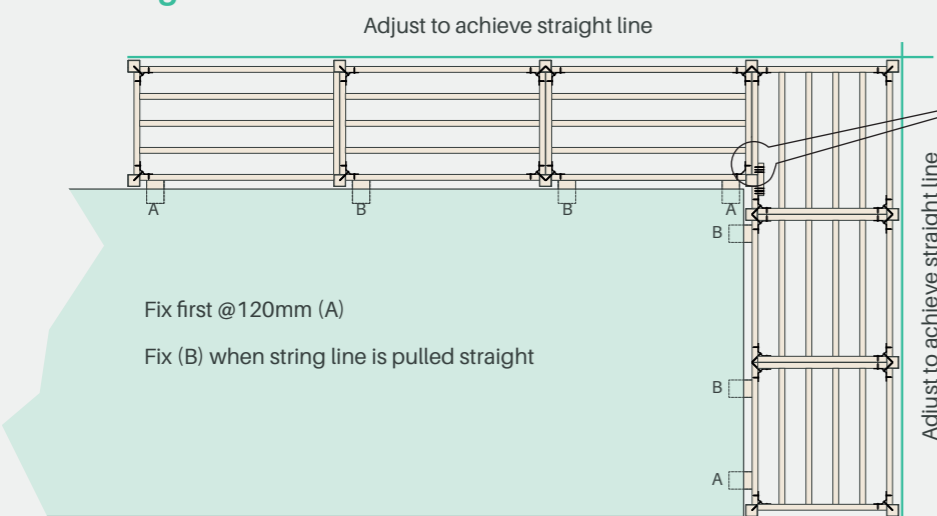

Bearers run parallel with caravan wall and boards will be laid at 90° to caravan wall

Steps badge

Steps badges are made externally and inserted into the frame.

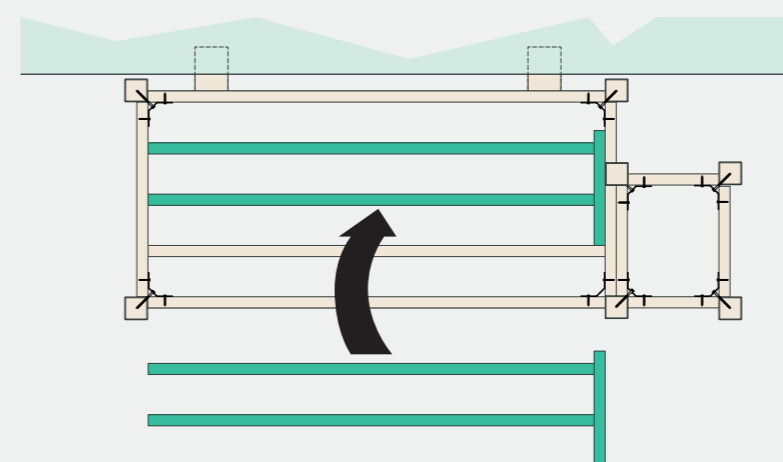

Finding the subframe height

Identify the lowest door frame on the sides of the caravan adjacent to the deck.

From this point, measure 35mm down and mark as a datum point for the string line.

The top of the subframe should be aligned to this datum point.

Attach lath to each end and run string line along side of subframes to ensure completely in line (caravan maybe out of alignment).

Tying the deck to the underside of the caravan

Use subframe offcuts 150 x 50mm nominal wooden lath to attach the subframe to the underside of the caravan leaving 120mm gap from subframe inner face to caravan side. Care to be taken not to block caravan / lodge ventilation paths.

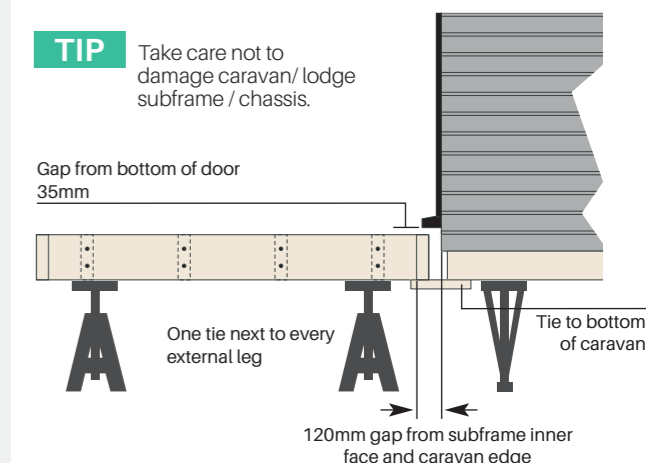

Dimensions of Steps

Steps

Fit steps at nominal 30° gradient using the dimensions shown below.

Position gates 700mm from outside of corner post to door retaining clip.

Allow a 40mm gap in addition to gate width for hardware

Where the steps meet the main subframe, the first board should be secured with an L clip, in the same way as the starter board on page 12.

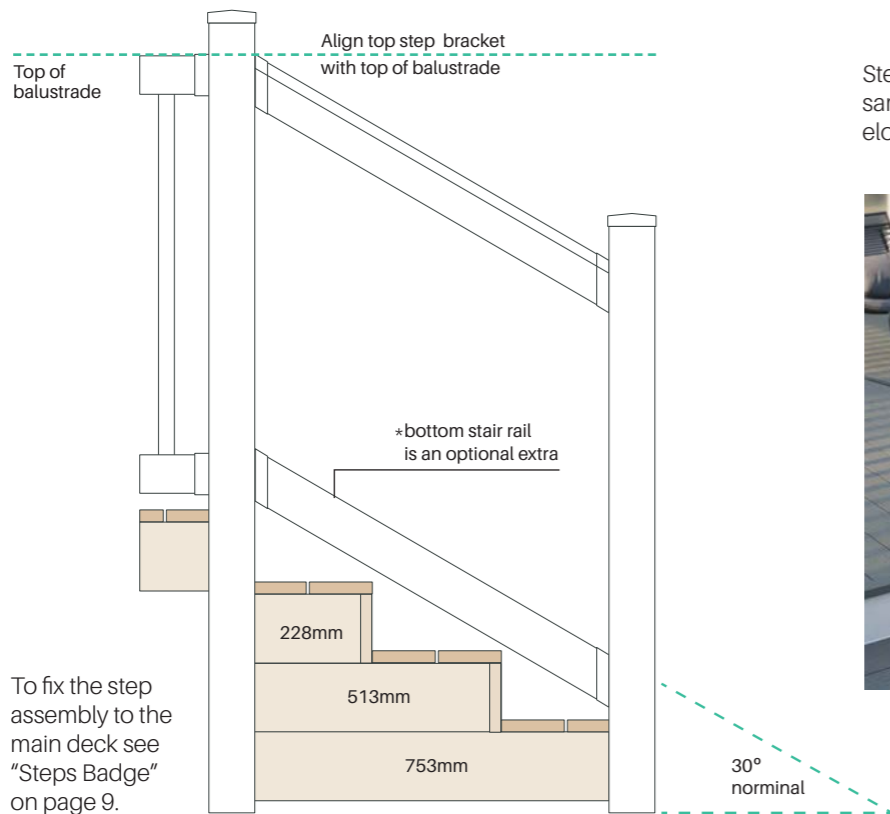

Step handrail option also available using the same dimensions, using handrail with elongated routed holes for pickets.



To fix the step assembly to the main deck see "Steps Badge" on page 9.

Note Dimensions give a 5mm tread overhang.

Dimensions for step subframes

3 tread - 843mm nominal 30°

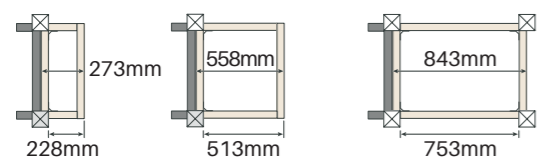

4 tread - 1128mm nominal 30°

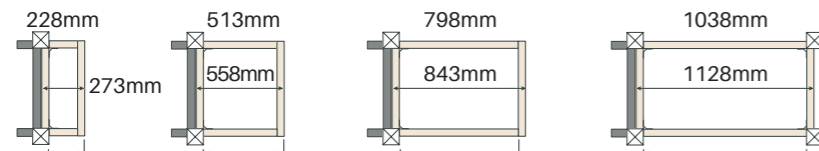

No. of Steps	For deck height range (mm)
3	580 to 724
4	725 to 869
5	870 to 1014

Subframe brackets to step subframes

Use 4 x Subframe brackets to the bottom step corners.
Use 2 x Subframe brackets to every other step, rear corners only i.e. closest to the main deck.

Ramp Installation



The British Standard for wheelchair ramps

The British Standard for wheelchair ramps -- BS8300 (2018) -- is a code of practice for designing buildings and their approaches to meet the needs of disabled people. Though it's not a legal requirement, it is best practice. The Standard aligns with the Building Regulations and recommends:

- that ramps have a maximum gradient of 1:12;
- the provision of handrails on both sides of the ramp for gradients steeper than 1:20.

Ramp design

It is important to select which design of ramp will be required for the particular job. The major factor will be the height of the caravan.

Consult the ramp ratio table on page 26, to determine the length of ramp needed to meet the required height.

The length of the ramp and position of the entrance door will then determine the type of ramp required.

It is recommended that ramps do not exceed a 1:12 ratio.

Ramp construction

- Construct and position the horizontal areas of the deck subframes
- Take measurements to determine which ramp ratio is applicable
- Position the ramp base plate according to the ramp ratio length dimension
- Run a string line from the ramp base plate to the horizontal area at the top of the ramp
- Construct ramp subframe to string line angle allowing for deck planks.

Handrails

Handrails are required with permanent wheelchair ramp installations to ensure that users can safely access the ramp. Where a ramp has a gradient steeper than 1:20, handrails must:

- be provided on both sides of the ramp;
- extend at least 300mm beyond the top and bottom of the ramp;
- be continuous with no obstructions or breaks;
- be easy to grip.

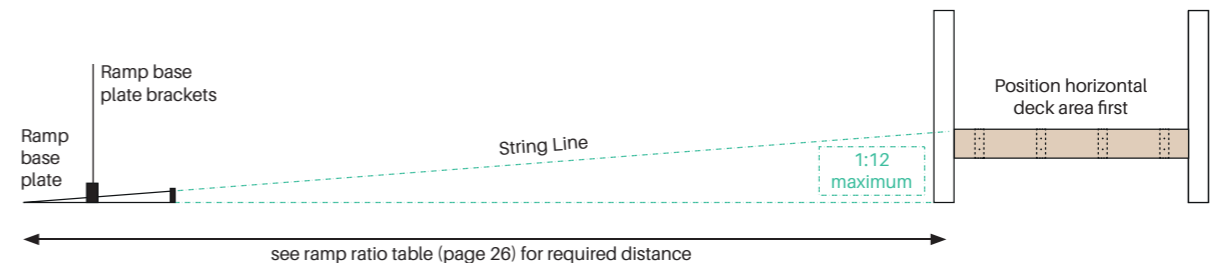

Typical ramp designs

In-Line ramp with access platform

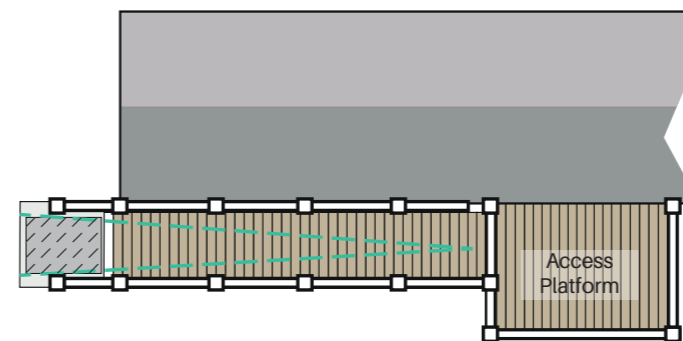

Double back ramp

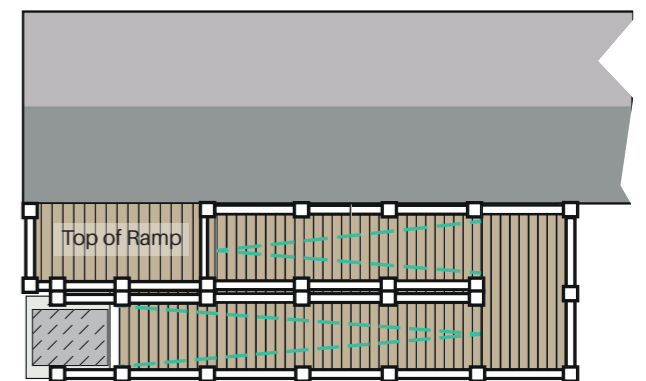

Key = Incline direction

Laying Decking Boards

Cutting around posts

Lay boards at 90° to caravan wall.
Leave a 2mm expansion gap, for the planks, around the post.

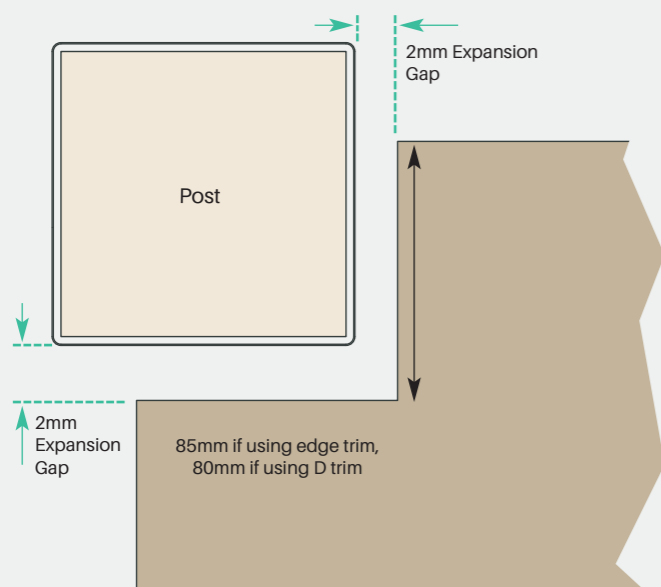

Starter board

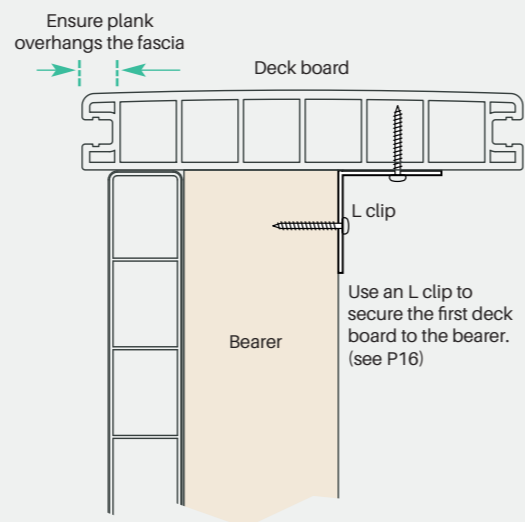

Deck and trim Installation

Attach edge trim to caravan end of the first deck plank. Install plank with clips leaving a minimum of 3mm between the trim and the caravan wall. Ensure all clips are correctly seated.

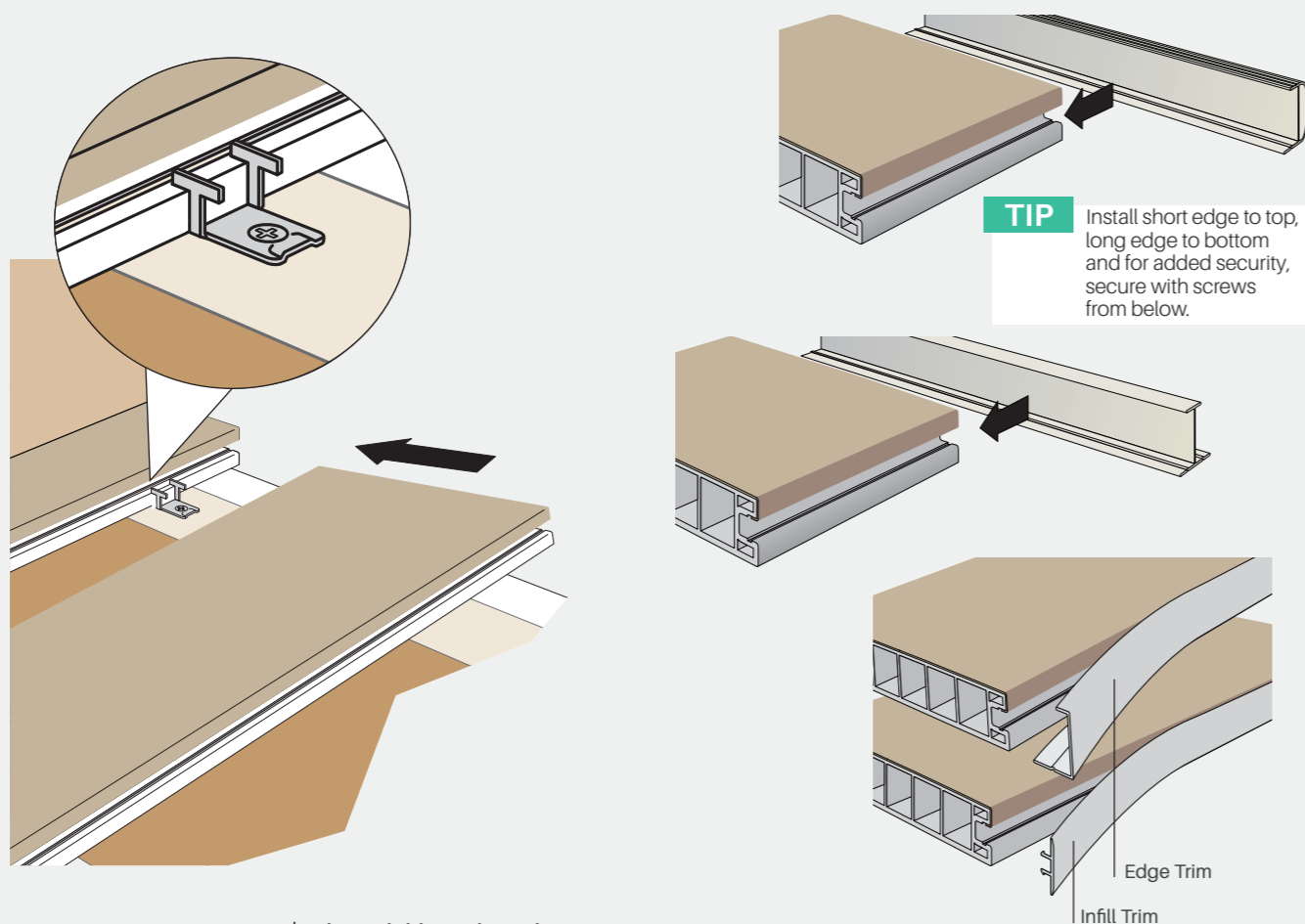

Joining Decking Boards

Where board ends meet, install a second bearer so that each board end is fully supported and secured with its own clip.

Allow a 5mm gap between board ends for expansion.

Where possible, the expansion gap can be left at the end of a run.

Note Adjacent boards have been removed from the drawing for clarity.

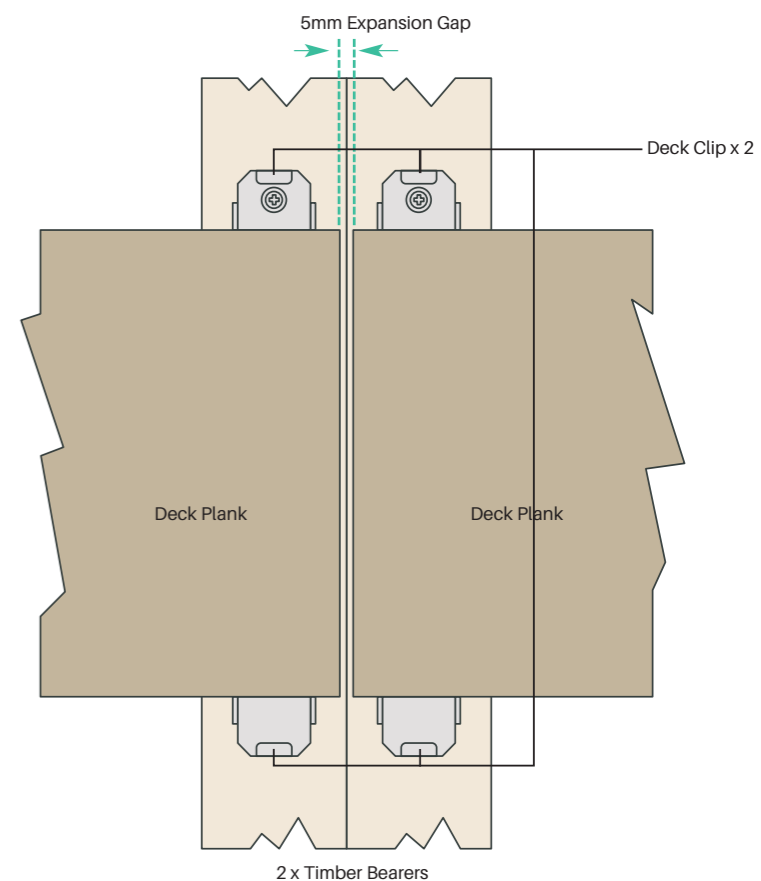

Staggered joints

Always overlap adjacent board end joints by a minimum of two bearers.

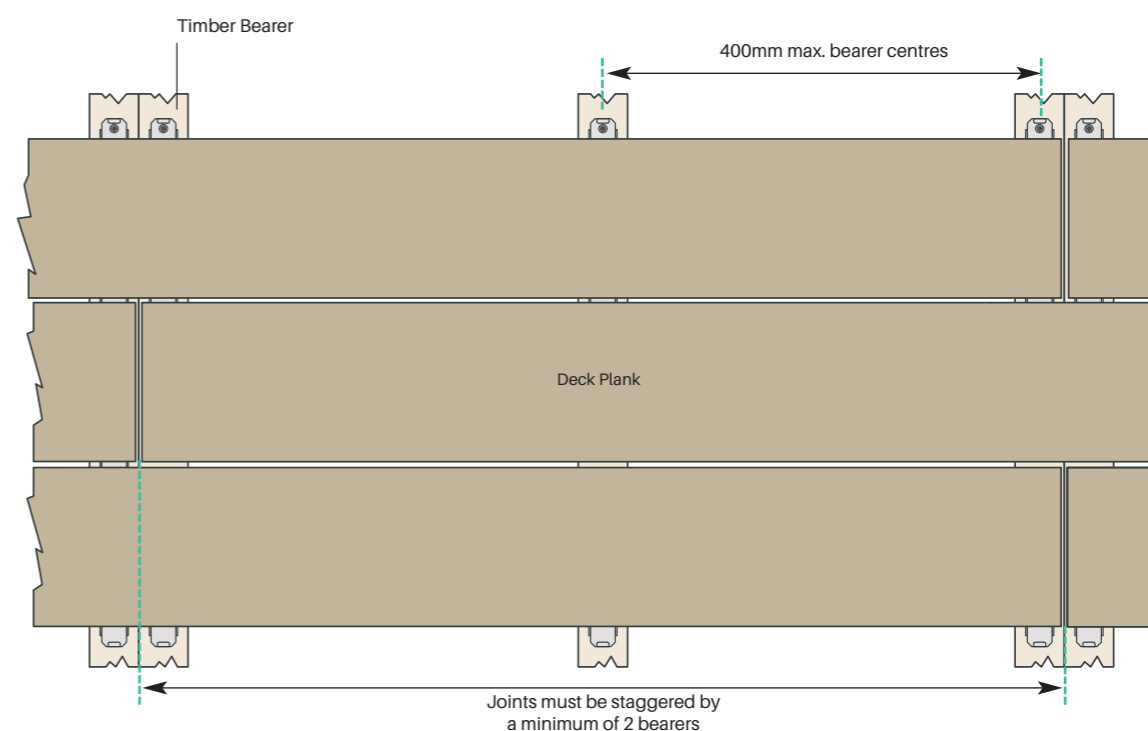

Balustrade Installation

1. Top and bottom rails should be cut to length - Distance between posts minus 18mm, allows for the thickness of two brackets and an expansion gap at each rail end. Gaps between last picket and post should not exceed 100mm.

Note Rails should be cut to keep picket spacing symmetrical.

2. U Reinforcement is cut to the same length as the PVC Rail and inserted in the following orientation. Drill 2 x 10mm diameter holes in the base of the bottom rail to allow for drainage.

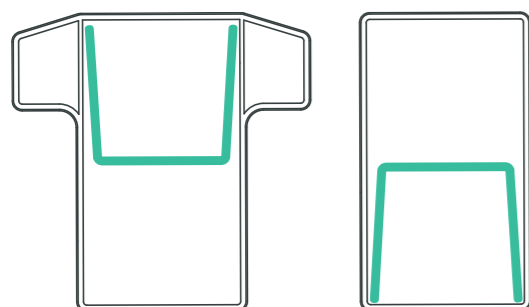

Note All bottom rails should have a minimum of 2 x 10mm diameter holes in the base to allow for drainage.

3. A foot block is secured to the underside of the bottom rail at the mid-point using a 30mm stainless wood screw.

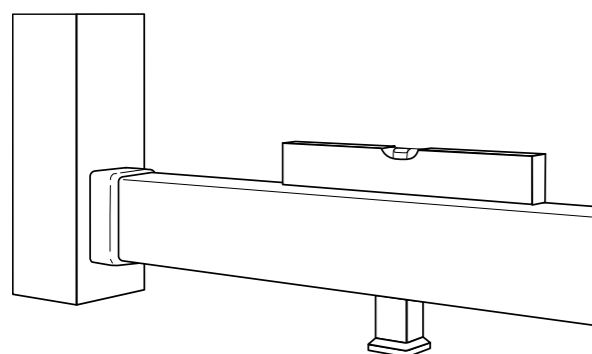

4. The height of the bottom rail bracket from the deck surface is obtained by placing the rail/foot block assembly into position with a bracket body on one end. When the bottom rail is level mark the position of the bracket onto the post or alternatively you may wish to use a jig to obtain the bracket positions. Brackets are secured using 4 off 30mm stainless steel countersunk wood screws.

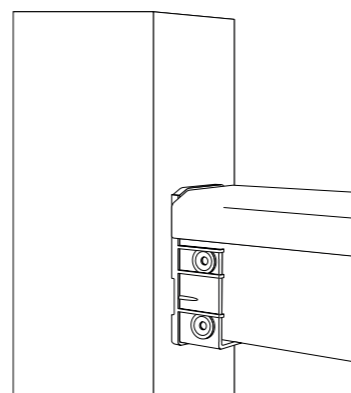

5. Assemble the top and bottom rails together with their pickets and drop the assembly into the bottom rail bracket bodies. Place a bracket body at each end of the top rail marking its position on the post. It should be possible to lean the rail and picket assembly aside to fit the bracket bodies. Secure using 4 off 30mm stainless steel countersunk wood screws.

6. Ensure that the rails/reinforcement are centrally positioned before securing the rail assembly to the brackets via the side holes in the bracket body with 2 x 4.8mm (no10) x 19mm Self Tapping Screws. The reinforcement should be piloted with a 3.5mm drill.

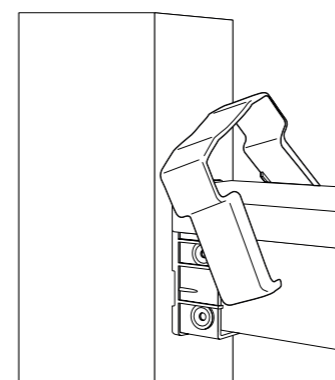

7. Brackets are finished by clipping on the bracket covers. (care should be taken not to over stress the covers).

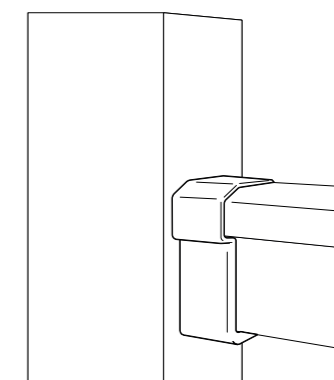

Picket Lengths

Pickets should be cut to size to match the rail height.

Allowance:

Allow 50mm for the footblock.

+

Allow 90mm for 2 x reinforcement bars & rail profiles.

=

Deduct 140mm from Rail Height for maximum picket length.

Example For an 900mm high balustrade, a 760mm picket would be required.

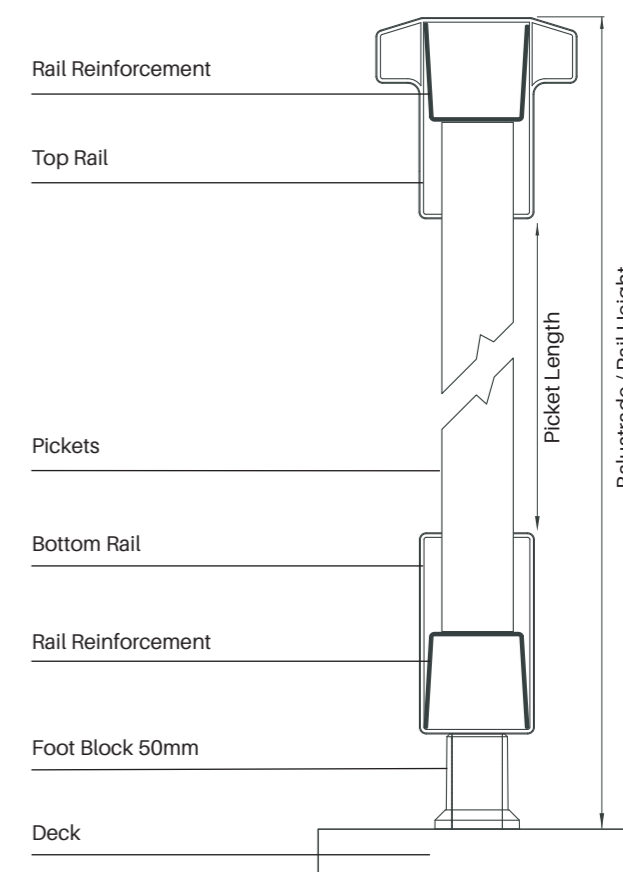

Fascia and Skirting Installation

Fascia Board - 150mm x 25mm Fascia

The Fascia Board is used for facing off the edge of the deck subframe in order to hide the timber bearers. The boards can be secretly fixed from behind the subframe using 60mm woodscrew (DWSCREW60) assuming that the timber substructure is at least 45mm deep.

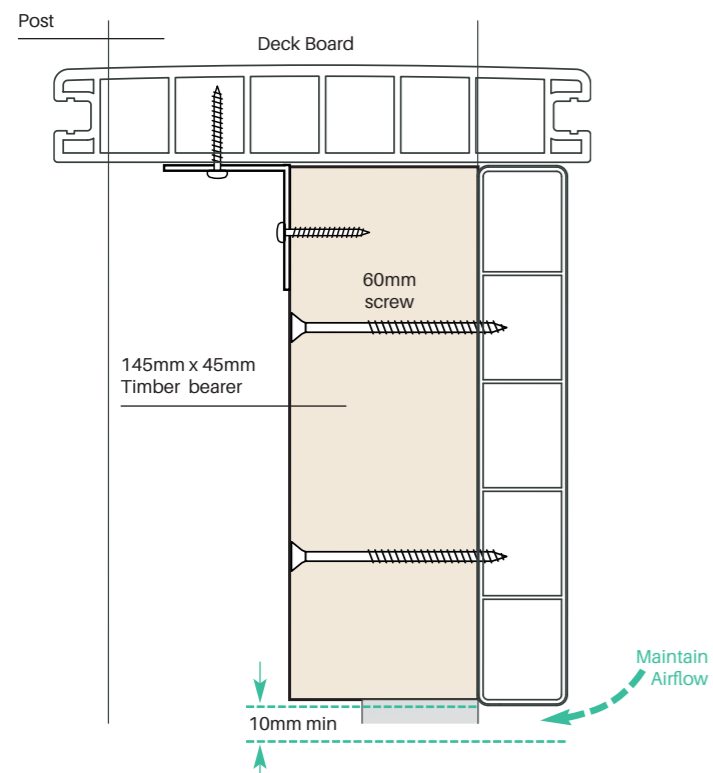

Always leave a minimum ventilation gap of 10mm below the subframe.

Single fascia installation requires the air gap to be at the lowest point of the fascia.

Note Keep area beneath the decking free from obstruction to maintain airflow with minimum 10mm gap.

Skirting Board - 150mm x 25mm Skirt

Skirting Board is used to cover the area under the subframe and fascia board.

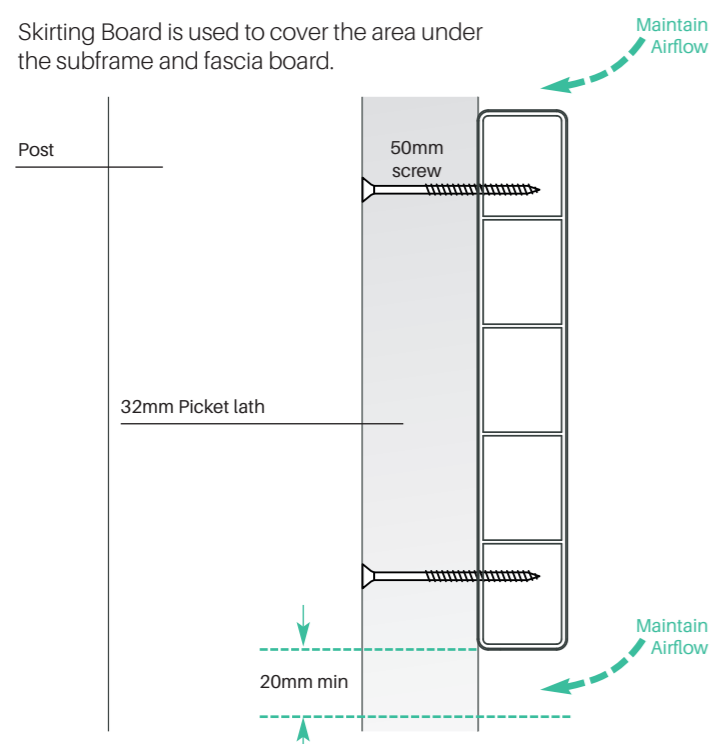

Always leave a minimum ventilation gap of 20mm between the skirting planks to promote airflow.

Fit through rear of the 32mm picket lath using 2 x 50mm screw at max 1200mm centres - see page 17

Note It is advisable that a minimum 20mm continuous ventilation gap is provided between skirting planks to provide adequate through ventilation

Product	Fixing	Centres
Fascia	2 x 60mm screw Fit through rear of the timber bearer	max 1200mm
Skirting	2 x 50mm screw Fit through rear of the 32mm picket lath	max 1200mm

Types of Skirting and Installation

Horizontal Ranch Style Skirting Deck Skirting

- Add a piece of 32mm picket to act as a lath to the inside of the post.
- Screw through the rear of the lath into the rear side of the skirting board.
- Fit an additional central lath where the skirting is more than 1200mm wide to prevent any bowing.
- Where the ground is uneven or sloping, cut the lowest skirt so that its top is horizontal and its bottom lays along ground level.

Skirting Clip Installation

- A skirting clip is available to aid installation. The clip provides a 20mm spacing between skirting planks.
- Fit the top plank first. A 4mm packer or cut down skirt clip may be required at the top.
- Fix every skirt clip with 1 x 30mm stainless steel screw.



Note Ranch style horizontal skirting / cladding to the install requires additional upright supports when the skirting width exceeds 1200mm. Secure to the underside of the subframe and ground.

Vertical Skirting

- Fix length of bottom rail routed for 150mm x 25mm picket to the underside of the unit and fix a second length to the ground
- Cut 150mm x 25mm picket to the required height (depth between unit and ground minus 130mm)
- Bottom rail requires a flexible material inserted to allow movement of and support picket insert
- Insert the 150mm picket between the top & bottom rail.

Note This option allows access under the decking & unit anywhere without the use of access panels / hatches.

Ranch Style

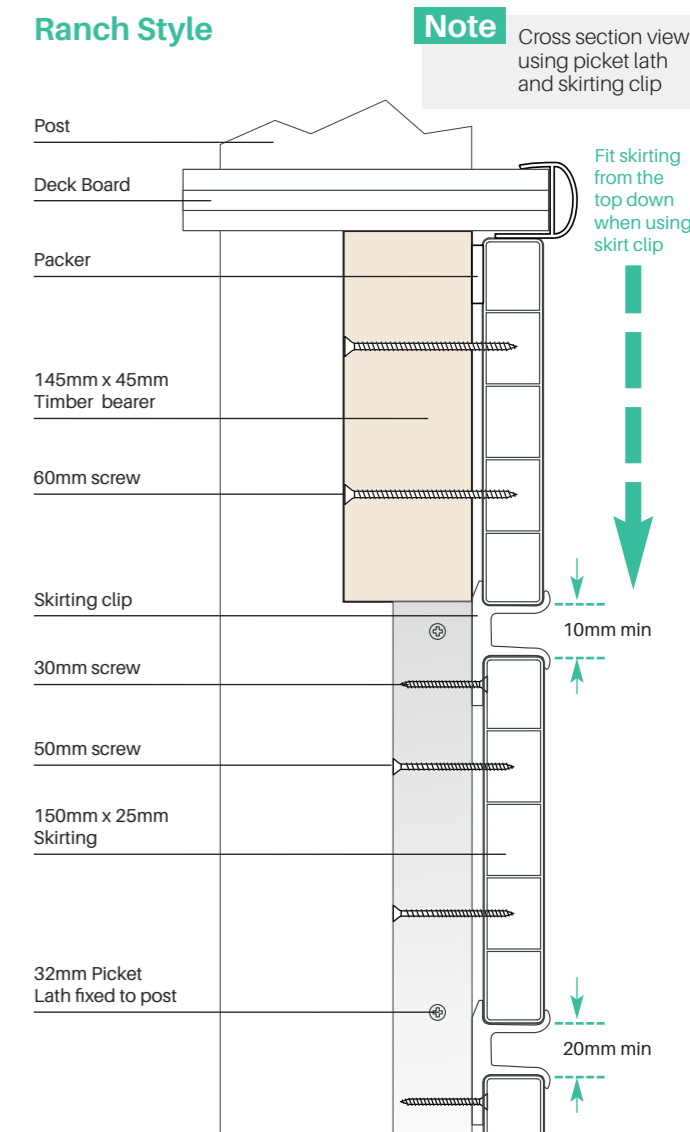

Vertical Skirting

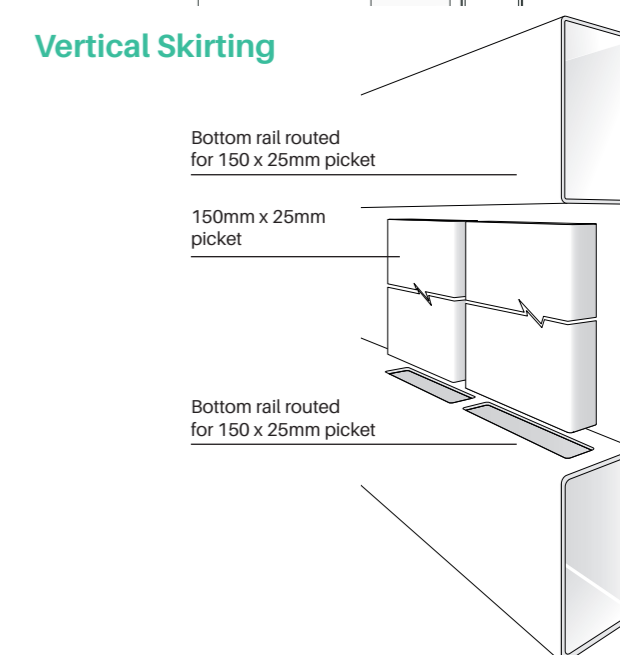

Welded Gates

To install

- Ensure there is a gap of at least 700mm between back of last post and caravan door retaining clip
- The gate should open on to the railing, not the caravan side.

IMPORTANT	ALWAYS leave 40mm for latch and hinges.
Example	For a 960mm wide gate the distance between posts should be 1000mm to allow for gate hardware.

- The top of the gate should be fitted in line with the top of the balustrade rail.
- The Bottom of the gate can be identified by 2 x drainage holes.
- Hinges should be positioned in between the top and bottom rail brackets.
- The hinge and latch pack contains all fixings for fitting to a timber reinforced post.
- Hinges are normally placed on the deck-side of the post and gate.
- The gate has timber reinforcement inside both vertical sides for the attachment of hardware.

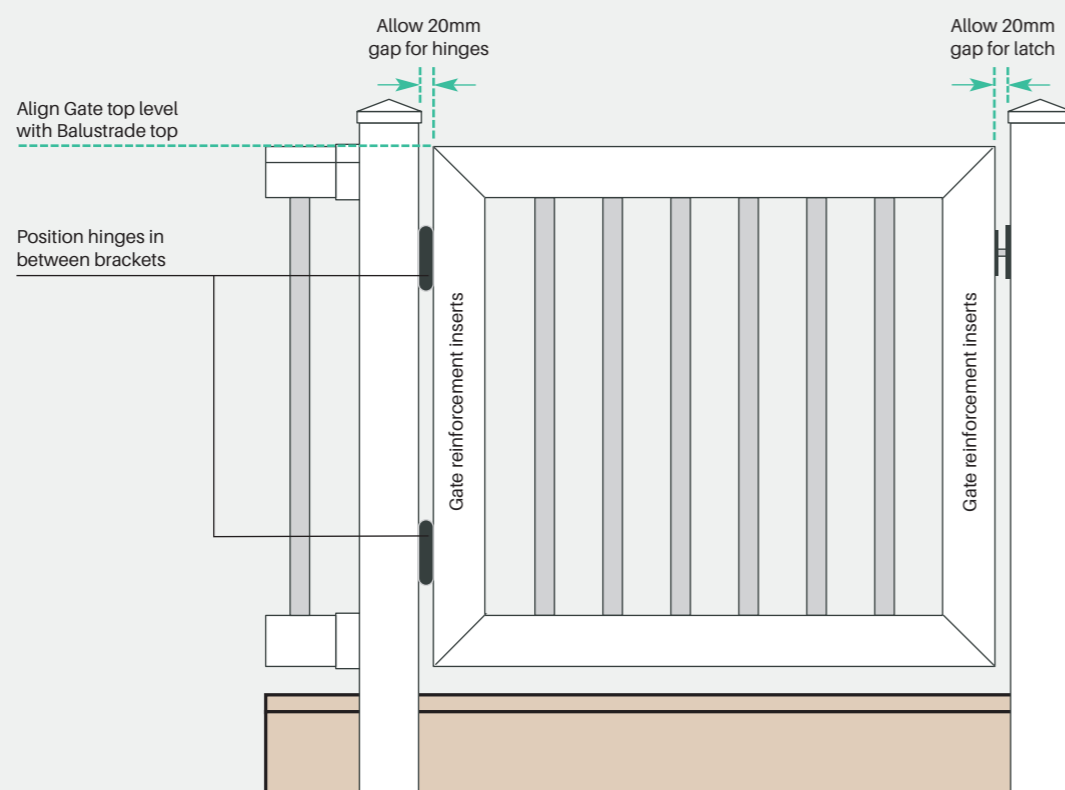

Post Light Cabling and Fitting

Installation

The Post Sleeve top must be cut square and level to ensure a solid base for the light assembly.

Note Consideration must be given to the position of the cable channel with regard to fixing screws **Fig.A**

Cabling for lights

When fitting lights, use a 95 x 95mm post with a 20mm x 20mm notch out of one side (**Fig. A**).

Run the cable in a loop up and down each post, ready for the electrician to terminate (**Fig. B**).

This will enable a loop from one light to the next via the wagos installed inside the light fixture.

Allowances for the light assembly

This will enable a loop from one light to the next via the wagos installed inside the light fixture.

The wooden post should be cut 35mm shorter than the post sleeve to allow for the light fitting hardware (**Fig. C**).

The PVC-U post sleeve should be cut 36mm shorter than a standard post.

Fittings	Recommended Fixings
Fixing Light Fitting to the wooden post	Use 2 x 30mm Stainless steel screws in the holes provided
Fixing Post Cap to Light fitting	Low modulus silicone to ISO 11600-F&G-25LM

LED driver specification

The lights all run on 12v DC which will require a 2 core cable running to each light.

To convert the 240V down to 12V, an LED driver, will be required. This should be installed at the start of the lighting project and protected from the elements.

Each light fixture requires approximately 5 watts from the LED driver. For every additional lamp installed an additional 5 watts of output will be needed.

Example:
To install 12 lights, a driver with an output of 60W will be required (**Fig. D**).

Fig. A

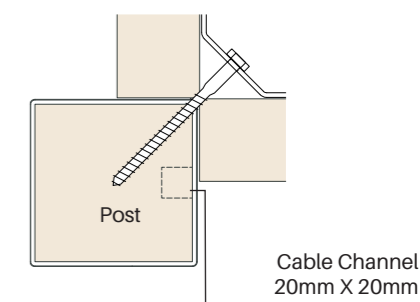

Fig. B

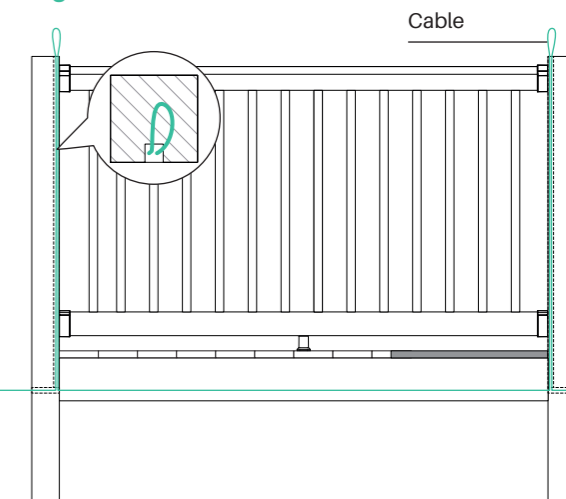

Fig. C

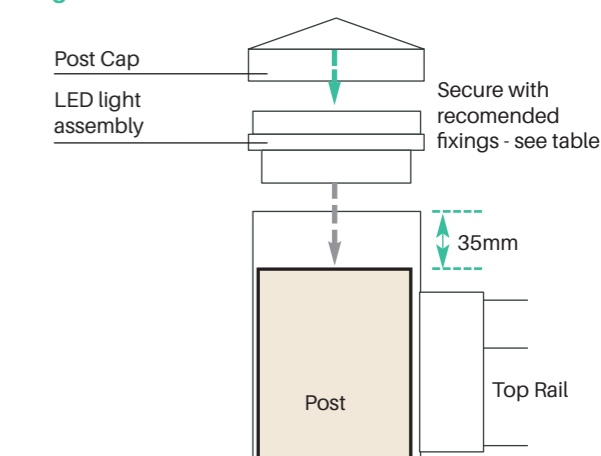

Fig. D





Note The LED driver should be located / installed where it will be protected from the elements.

Important It is recommended that a qualified electrician carries out connection of ALL wiring.

Key Dimensions

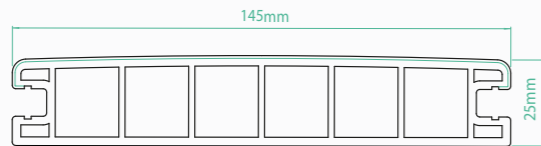
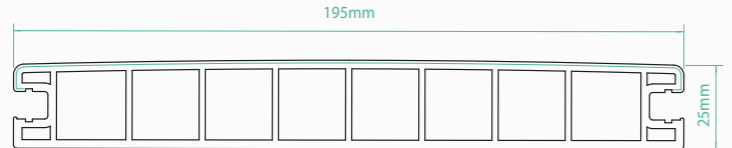
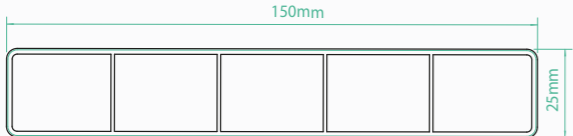
Decking and accessories

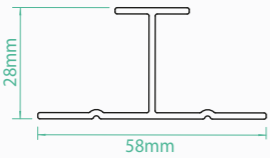
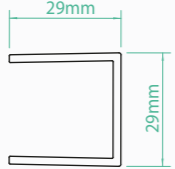
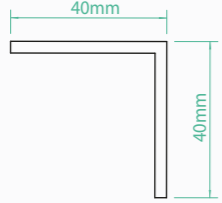
	Code	Description
	DDBP4902	DekBoard 145mm Plank
	DDBPLUS4902	DekBoard PLUS 195mm Plank
	DPICK6	150mm x 25mm Fascia / Skirt / Picket
	DINFILL	Infill Trim
	DEdge DDTRIM	Edge Trim D Trim
	DJOINT	Deck Joint
	DCHAN	U Channel
	DFANG	Angled Trim

*ALL dimensions are nominal values only

Balustrade and accessories

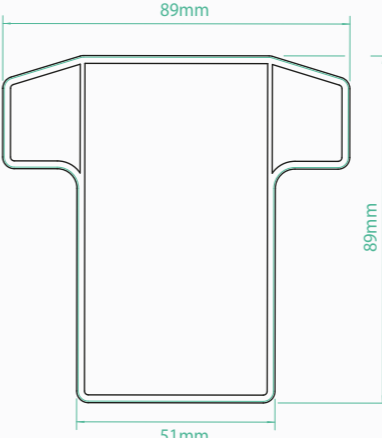
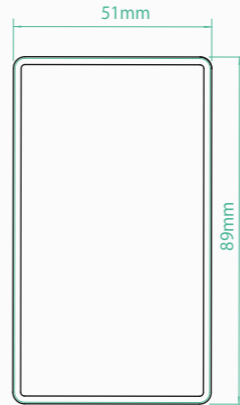
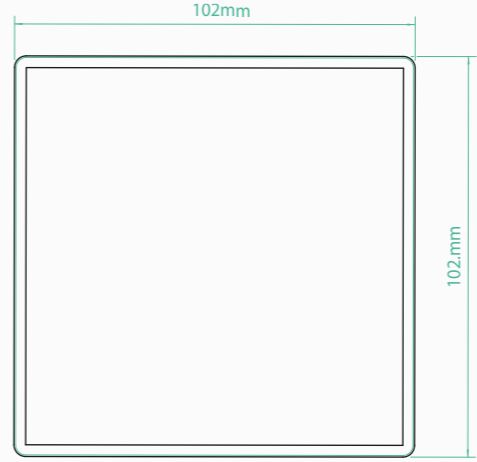
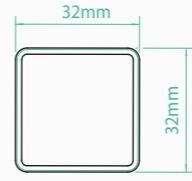
	Code	Description
	DTRAIL	Top Rail
	DBRAIL	Bottom Rail
	DPOST	Post Sleeve
	DPICK1	32mm Picket

*ALL dimensions are nominal values only

Fixing Summary

The following tables are a summary of full fixing instructions which are covered previously in this guide. Please refer to the full section for more details

Groundworks / Preparation Details		
Deck Plan	Detailed Plan	It is important to pre-plan the deck area. Plan the deck to make best possible use of materials. This can result in reduced waste. For example, working to full lengths will reduce the amount of joints required.
Foundations	Timber post ends / intermediate supports	Post ends should be set onto a stable well drained surface.
Foundations for Posts	All posts to be fully supported	If using concrete pads, checks should be undertaken to ensure ground stability
Ground membrane	Weed Control	To be positioned at ground level as required

Ventilation		
Ventilation to subframe / deck area	To reduce heat build-up	It is essential that a minimum 10mm continuous ventilation gap is provided underneath the base of the deck, providing thorough ventilation. Using recommended timbers, air gap and DekBoard will result in a minimum deck surface height of 185mm.

Subframe - General Fixing Details		
Subframe general fixing	Anchoring into masonry	Hammer screws recommended
	Anchoring into steel	Self-tapping screws recommended
	Anchoring into timber	Plated woodscrews recommended

Subframe - Construction Details		
Subframe construction	Timber	Nominal 150mm x 50mm (6" x 2"). 145mm x 45mm min. All timber used to build the subframe including posts should be at least C16 in quality (C24 is recommended) and treated appropriately for outdoor use.
	Max size (per unit)	Subframe should be constructed in sections - 2.22m x 2.22m max. per section
	Jointing	Use a minimum of 2 x 90mm external quality wood screws at each joint between subframe sections.
	Support	Subframes MUST be supported at maximum 2.22m spans
	Joist Spacing	Deck bearers should not exceed 400mm (16") centres, with a max 300mm (12") centres recommended in high foot traffic areas.
	Joist Noggins	Maximum 1.11m span between noggin centres
Subframe Bracket fixings	1 per subframe corner	Use 2 x 100mm coach bolts, 8 x 40mm panhead screws

Important Points Which Must Always Be Observed:		
<ul style="list-style-type: none"> • Ensure decking subframe system is fully supported • Maintain the correct statutory airspace to the decking system 		

Post - Construction Details		
Post Sleeve Re-inforcement	Reinforcement	Post Sleeves require reinforcing with timber at nominal 95mm x 95mm. Alternatively 2 x 95 x 47mm timbers screwed together at max 400mm centres can be used. Timber should be class C16 or C24. It is recommended that timber is glued on mating faces.2
Posts	Placement	Posts are required at every subframe unit corner.
Posts- Intermediate	Placement	Subframes MUST be supported at maximum 2.22m spans
Post	Height	Standard post heights are set 995mm from the top of the subframe.
Post Caps	Fixing	Fix Post caps with Low modulus silicone to ISO 11600-F&G-25LM
Post Electrical Cabling Channel	Placement	Consideration must be given to the position of the cable channel with regard to fixing screws.

Decking Fixing Details		
Deck Board fixing	First Plank	Use an L clip to secure the first deck board to the bearer
	Subsequent Planks	Install a clip at every bearer making sure they are correctly seated.
Deck Plank Jointing	Jointing	Wherever possible, plan to use full lengths to reduce waste / number of joints. Where joints are made end to end an expansion gap must be left. Every plank end must be secured to a bearer with 2 x Deck Clips. Where 2 planks meet; 4 x clips plus 2 x bearers will be required.
Expansion Gap	All colours	Allow 5mm between board ends.
Deck Finishing Trims	Joint Strip	Deck Joint is used to join boards linear or when boards meet at an angle to each other.
	Front Edge	Use Edge Trim or D trim to finish outward facing edge. Place longest edge of trim to the underside of the deck plank
	Rear Edge	Use Edge Trim to finish inward facing edge. Place longest edge of trim to the underside of the deck plank
	Infill Trim	Use Infill trim where plank side faces outwards e.g. when constructing steps
Fixing Centres	Deck Plank 145mm / 195mm	1 deck clip per fixing centre, max 400mm centres 1 deck clip per fixing centre, max 300mm centres in high traffic areas
Fascia fixing	To cover subframe	Fix through rear of subframe using 2 x 60mm screws @ 1.2m centres
Skirting fixing	To cover gap under deck	Fix through picket lath using 2 x 50mm screws @ 1.2m centres

Balustrade Fixing Details		
Balustrade Height	Minimum Height	The recommended minimum height of the rail is 900mm
	Foot Block Allowance	The foot block is 50mm high. The bottom rail will therefore start 50mm above the deck surface. Foot block fixed to rail with 1 x 30mm s/steel screw.
Balustrade Length	Expansion gap allowance	Rails should be cut to length equal to the distance between posts minus 18mm. This allows for two brackets and an expansion gap at each rail end.
	Balancing the rails (visual)	Rails should be cut to keep picket gaps symmetrical. Gaps between the last picket and ost should not exceed 100mm.
Bracket Fixing	All Brackets	Brackets are secured using 4 x 30mm stainless steel countersunk wood screws.
Reinforcement Fixing	Rails and Reinforcement Channels	Position the rails/reinforcement centrally before securing the rail assembly to the brackets. Fix via the side holes in the bracket body with 2 x 4.8mm (no.10) x 19mm Self Tapping Screws. The reinforcement should be piloted with a 3.6mm drill.

Gate Fixing Details		
Gate Location	Gate Position	Ensure there is a gap of at least 700mm between back of last post and caravan door retaining clip. Gate should open on to railing, not caravan side
Gate Furniture	Allowance for gate furniture	Leave 20mm either side of gate for latch and hinges e.g. a 960mm gate will need a 1000mm gap.
Gate Height	Height dependent on rail height	Top of the gate should be fitted in line with the top of the balustrade rail. Hinges are positioned in between rail brackets.
Gate Hinges / Latch fixing		Position Hinges / Latch in between rail brackets. Use supplied fixings only.

General Fixing Details		
Joint Fixing	Secure Post Caps	Low modulus silicone to ISO 11600-F&G-25LM.
Installation Temperature		To be installed between 5°C & 30°C temperatures
Storage Prior to fitting		Profiles are delivered in sealed in polythene sleeves. Store flat in their protective packaging on a clean, level surface in stacks not exceeding 1 metre high and restrained from collapse. Where the packs are stored externally, additional protection should be provided against the weather and accidental damage. Where possible all products should be stored indoors to prevent any water ingress to the packaging and during excessively hot weather the removal of the possibility of heat build up and subsequent distortion of the product within the packaging.

Applying the Finishing Touches

Edging Trim

- Apply edge trim or D trim to exposed end / edge of deck planks
- Fit Infill Trim to the deck edge which meets the top of the steps.
- Screw steps down at each end and secure edge trim onto the open plank ends
- Use infill on step tread front face and edge trim on step tread sides.

Post Caps

- Add post caps and / or lights to each post.

Glass Balustrades

- Call us to enquire about Glass Balustrades.

Hot Tubs

- Call us to enquire about Hot Tubs.

Deck Joint

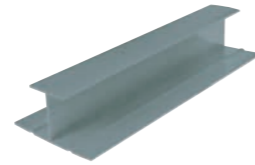

Edge Trim

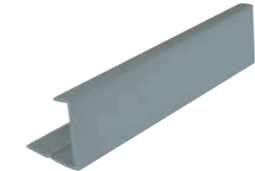

D Trim

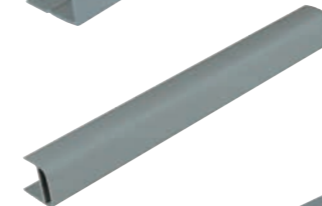

Infill Trim

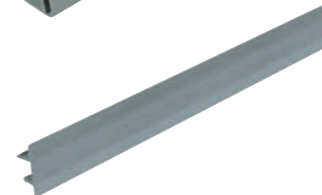

Post Cap

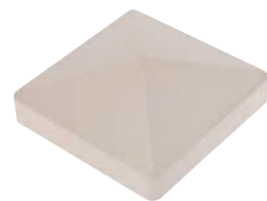

LED Light Assembly



Maintenance and Aftercare

To keep your low maintenance DekBoard product in top condition, we recommend cleaning your decking & balustrade with hot soapy water at least twice a year.

- Ensure adequate ventilation underneath your decking - Keep area beneath your decking free from obstruction.
- Ensure ventilation around the hot tub of a 25mm gap is free from obstruction.
- Jet washers on a low pressure setting can be used for the decking boards only.
- DO NOT USE JET WASHERS ON FOILED BALUSTRADE.

Cleaning & care:

- Clean your balustrade with a cleaning solution of warm soapy water using a cloth or sponge.
- Clean your decking with a cleaning solution of warm soapy water using a cloth, sponge or soft bristle brush.
- DO NOT place ANY hot surfaces or use BBQs in the vicinity of the decking.
- DO NOT use any glass/PVC cleaning products or any forms of bleach or solvent.
- DO NOT scrub your decking or balustrade with any abrasive products, such as scourers, sandpaper, stiff or wire brushes etc.

Additional tips:

- Some brands of sun cream can permanently stain foiled balustrade finishes.
- DO NOT place rubber mats or rubber backed mats anywhere on the decking area.
- Please note, to ensure warranty remains intact please ensure above Maintenance and Aftercare Guide lines are adhered to.

Summary of DekBoard Aligned Techniques and Values

General

- Observe site rules, ensure you have the correct permissions, tools, PPE, and vehicular access
- Use the entire DekBoard system

Etiquette and housekeeping

- Work neatly and safely
- Ensure all noise is kept to a minimum and consideration is given to nearby residents and park colleagues
- Represent DekBoard and the DekBoard family in a positive way
- Make good any damaged grass areas and sweep away any debris
- Take ALL offcuts and rubbish away with you and dispose of responsibly, recycling where possible.
- Sweep and wipe down



Low Maintenance



Slip Resistant



Robust



100% Recyclable



Long Life



Product Testing



Call
**CUSTOMER
SERVICES**
to enquire about
**Hot tubs
& Glass
Balustrades**

Specifications and conversion tables

Rail picket Information

Standard Picket spacing Using Picket : 32mm x 32mm (1¼ " x 1¼ ")					30" Picket spacing Using Picket : 32mm x 32mm (1¼ " x 1¼ ")				
Rail length (m)	Picket orientation	Nominal Space between pickets (mm)	Picket Centre (mm)	Qty Pickets required	Rail length (m)	Picket orientation	Nominal Space between pickets (mm)	Picket Centre (mm)	Qty Pickets required
1.828	■	92	124.25	14	1.828	■	75	124.25	14
1.828	◆	91	133.95	13	1.828	◆	73	133.95	13
2.438	■	98	130.25	18	2.438	■	81	130.25	18
2.438	◆	95	137.95	17	2.438	◆	77	137.95	17

Skirting Plank Picket spacing Using Picket : 150mm x 25mm (6 " x 1 ")				
Rail length (m)	Picket orientation	Nominal Space between pickets (mm)	Picket Centre (mm)	Qty Pickets required
4.876	■	34	184.5	26

All dimensions calculated to +/- tolerance

Ramp Ratio 1:12										
Height (mm)	150	200	250	300	350	400	425	450	475	500
Ramp length (mm)	1800	2400	3000	3600	4200	4800	5100	5400	5700	6000
Height (mm)	550	575	600	625	650	675	700	725	750	775
Ramp length (mm)	6600	6900	7200	7500	7800	8100	8400	8700	9000	9300

Ramp Ratio 1:15										
Height (mm)	150	200	250	300	350	400	425	450	475	500
Ramp length (mm)	2250	3000	3750	4500	5250	6000	6375	6750	7125	7500
Height (mm)	550	575	600	625	650	675	700	725	750	775
Ramp length (mm)	8250	8625	9000	9375	9750	10125	10500	10875	11250	11625

Ramp Ratio 1:20										
Height (mm)	150	200	250	300	350	400	425	450	475	500
Ramp length (mm)	3000	4000	5000	6000	7000	8000	8500	9000	9500	10000
Height (mm)	550	575	600	625	650	675	700	725	750	775
Ramp length (mm)	11000	11500	12000	12500	13000	13500	14000	14500	15000	15500

	Code	Unit	Application	Notes
 Coach Bolt (100mm)	DCBOLT	Box 50	Subframe Bracket to Post	Stainless Steel 13mm head
 Wood Screw Countersunk (90mm)	DWSCREW90	Box 100	General subframe assembly	Yellow plated- no pilot hole required (60mm of thread)
 Wood Screw Countersunk (60mm)	DWSCREW60	Box 200	Fascia board to subframe	Yellow plated- no pilot hole required
 T Star Washer Head Screw (60mm)	Non stock item		Step Tread	Stainless steel
 Wood Screw Countersunk (50mm)	DWSCREW50	Box 200	Fascia board with lath	Yellow plated- no pilot hole required
 Wood Screw Pan Head (40mm)	DWSCREW40	Box 100	Subframe Bracket to frame	Stainless steel
 Wood Screw Countersunk (30mm)	DWSCREW30	Box 1000	Deck Clips Fixed Position starter board Rail Brackets	Stainless Steel
 L Clip	Non stock item		L Clip	19 x 19mm Steel Angle Brace

Conversions

Conversions	
Feet	Metres
1	0.30
2	0.61
3	0.91
4	1.22
5	1.52
6	1.83
7	2.13
8	2.44
9	2.74
10	3.05
11	3.35
12	3.66
13	3.96
14	4.27
15	4.57
16	4.88
17	5.18
18	5.49
19	5.79
20	6.10
21	6.40
22	6.71
23	7.01
24	7.32
25	7.62
26	7.92
27	8.23
28	8.53
29	8.84
30	9.14
31	9.45
32	9.75
33	10.06
34	10.36
35	10.67
36	10.97
37	11.28
38	11.58
39	11.89
40	12.19
41	12.50
42	12.80
43	13.11
44	13.41
45	13.72
46	14.02
47	14.33
48	14.63
49	14.94
50	15.24

DekBoard quantity & information

145 Plank		DekBoard PLUS Plank	
deck size @ 0.145mm	Number of boards	deck size @ 0.195mm	Number of boards
0.150	1	0.200	1
0.300	2	0.400	2
0.450	3	0.600	3
0.600	4	0.800	4
0.750	5	1.000	5
0.900	6	1.200	6
1.050	7	1.400	7
1.200	8	1.600	8
1.350	9	1.800	9
1.500	10	2.000	10
1.650	11	2.200	11
1.800	12	2.400	12
1.950	13	2.600	13
2.100	14	2.800	14
2.250	15	3.000	15
2.400	16	3.200	16
2.550	17	3.400	17
2.700	18	3.600	18
2.850	19	3.800	19
3.000	20	4.000	20
3.150	21	4.200	21
3.300	22	4.400	22
3.450	23	4.600	23
3.600	24	4.800	24
3.750	25	5.000	25
3.900	26	5.200	26
4.050	27	5.400	27
4.200	28	5.600	28
4.350	29	5.800	29
4.500	30	6.000	30
4.650	31	6.200	31
4.800	32	6.400	32
4.950	33	6.600	33
5.100	34	6.800	34
5.250	35	7.000	35
5.400	36	7.200	36
5.550	37	7.400	37
5.700	38	7.600	38
5.850	39	7.800	39
6.000	40	8.000	40
6.150	41	8.200	41
6.300	42	8.400	42
6.450	43	8.600	43
6.600	44	8.800	44
6.750	45	9.000	45
6.900	46	9.200	46
7.050	47	9.400	47
7.200	48	9.600	48
7.350	49	9.800	49
7.500	50	10.000	50

Test Results

Slip resistance testing

DekBoard decking is an extruded PVC profile that has a timber effect pattern impressed into the tread surface.

The decking profile has an excellent level of slip resistance under either wet or dry conditions. This due to:

- the slightly convex nature of the tread surface which is able to shed water rapidly even when laid level
- the raised pattern on the tread surface which provides good contact between footwear and the deck.

DekBoard® has been tested for slip resistance at Ecodek, a sister company to DekBoard within the Epwin Group (Sept 2018).

The test regime was carried out to CEN/TS 15676. According to HSE guidelines, a Low Slip Potential classification is achieved with a value equal to or greater than 36.

DRY Horizontal	DRY Vertical	DRY 45°	Average All	WET Horizontal	WET Vertical	WET 45°	Average All
47.0	65.0	59.0		42.0	55.0	51.0	
47.0	65.0	58.0		43.0	54.0	51.0	
48.0	62.0	59.0		41.0	53.0	50.0	
47.0	64.0	60.0		42.0	54.0	51.0	
46.0	65.0	59.0		43.0	53.0	51.0	
48.0	63.0	58.0		43.0	54.0	50.0	
49.0	65.0	60.0		42.0	53.0	51.0	
47.0	64.0	61.0		43.0	53.0	50.0	
48.0	64.0	58.0		42.0	54.0	51.0	
47.0	63.0	58.0		42.0	53.0	51.0	
47.4	64.0	59.0	56.8	42.3	53.6	50.7	48.8

Fire performance

DekBoard has been tested for reaction to fire in accordance with BS EN 13501-1:2018 and achieved an overall classification of Class Bfl-s1.

BS EN 13501-1:2018

Under BS EN 13501-1:2018 the fire classification of construction products and building elements are considered in relation to their end use or application.

The Standard sets out the reaction to fire classification procedure for the majority of construction products, including products incorporated within building elements.

There are three main product categories:

- Construction products, excluding floorings and linear pipe thermal insulation products.
- Floorings.
- Linear pipe thermal insulation products.

DekBoard has been tested under the Floorings category to BS EN ISO 9239-1:2010* Reaction to fire tests for Floorings and BS EN ISO 11925-2:2010 Single-flame source test.

This method is applicable to all types of flooring ranging from metal through to wood and synthetic materials. Results obtained by this method reflect the performance of the flooring, including any substrate if used.

*ISO 9239-1:2010 specifies a method for assessing the wind-opposed burning behaviour and spread of flame of horizontally mounted floorings when exposed to a heat source.

Classifications	Reference	Typical Examples of Products
A1 fl	Non flammable	Metal, concrete, stone
A2 fl	Non flammable	Steel, metal with finishes
B fl	Flame-retardant products	Gypsum, DekBoard
C fl	Flame-retardant products	Hardwood
D fl	Normally flammable products	Softwood, linoleum, OSB
E fl	Normally flammable products	Laminate
F fl	Easily flammable products	Carpets

Load span technical information

All DekBoard® decking products have been load tested.

DekBoard® point loads tested at different spans.

Table 1 shows point loads against spans to ensure you can choose the correct bearer spacing to ensure you comply with 'BS EN 1991-1-1:2002 Actions on structures - Imposed loads for buildings'.

Table 1.	DekBoard		
SPAN (mm)	300	350	400
Max point load (kN)*	5.0	4.2	3.6

Point loads requirements for different flooring media (BS EN 1991-1-1:2002).

Table 2 below shows an extract from BS EN 1991 that demonstrates what point loads the flooring media should be able to support. These loads are mid-span live loads. Dead loads should be supported in a different manner whereby the load is spread over the support beams to ensure long term board deflection is prevented.

Table 2.	Point Load kN (mid-span)
BS EN 1991-1-1:2002 Actions on structures - Imposed loads for buildings	
Balconies	2.0
Walkways - Light duty	2.0
General residential	2.0
Offices for general use	2.7
Public, institutional and communal dining rooms and lounges, cafes and restaurants	3.0
Classrooms	3.0
Assembly areas with fixed seating	3.6
Walkways - General duty	3.6
Assembly areas without seating, concert halls and bars	3.6
Shopping areas - General	3.6
Stairs & landings in all buildings incl. hotels & institutional buildings subject to crowds	4.0
Corridors, hallways, aisles, in all buildings incl. hotels & institutional buildings subject to crowds or wheeled vehicles incl. trolleys	4.5
Walkways heavy duty (high density pedestrian traffic including escape routes)	4.5

It is important to ensure you design your substructure to comply with the uniformly distributed load (UDL) values (commonly expressed in kN/m²), which are also expressed in BS EN 1991.

*Test conducted at 19°C

DekBoard Product Guarantee - Authorised Installer



10 Year Product Guarantee

This **DekBoard** (the Manufacturer) **Product Guarantee** (the Guarantee) is only available via DekBoard Authorised Installers (the Installer) who are independent companies authorised to install DekBoard products.



Terms and Conditions

- The Guarantee Period shall be 10 years from the date of installation.
- The Guarantee only applies where product defects appear within the Guarantee Period and is reported in writing within 14 days. Claims should consist of a full description of the fault and photographic evidence.
- The sole and exclusive remedy with regard to the Guarantee is limited to the repair or supply of replacement product at the Manufacturer's discretion, after consultation and agreement with the Installer. The Manufacturer does not make any other representation or guarantee and in no event shall the Manufacturer be liable for any other loss or damage whether direct or indirect (including but not limited to the cost of installation).
- The Products are guaranteed not to suffer from structural failure resulting from fungal decay, termites, rotting, splintering or splitting for a period of 10 years from the date of installation, provided that the Products have been installed by the Installer in accordance with the DekBoard Installation Guide and have been subjected to normal use and service conditions.
- No further guarantees are offered on durability, impact resistance, abrasion resistance, stain resistance, resistance to scratching or performance under abnormal weather conditions, fair wear and tear, aggressive industrial conditions, inappropriate applications or malicious/accidental damage.
- The Guarantee does not cover changes or variations in colour of the products.
- The Guarantee is limited to end use of the Products in Northern Europe (latitude 45° to 60°) and at elevations below 1800 metres above sea level, and where the Products have been stored and installed in temperatures between 0°C and 30°C.
- The Guarantee does not cover any movement, distortion, collapse or settling to the ground or supporting structure on which the products are installed and which may cause damage to the product.
The following conditions will be precedent to any liability hereunder:
 - Full payment for the installation covered by this guarantee.
 - The Manufacturer's recommended maintenance procedures being followed or in the absence of such recommendations, normal and reasonable maintenance being undertaken.
 - The Products have not been coated or had any other process or repair performed on them.
 - The defect is not caused by willful or accidental damage, vandalism or negligence.
 - The Products have not been exposed to atmospheric pollution, acid rain, harmful chemicals or vapours, fire, lightning, flood, abnormal winds or earthquakes, or the effects of external heat sources or reflective surfaces, or undue wear and tear, or other unusual conditions such as (but not strictly limited to): hot coals from fire pits/barbecues, solvents/bleach/sun cream, rubber backed mats/jet washers and damage caused by animals.
 - The Products have not been moved from the site where the defect is alleged to have occurred.

Your rights:
If there is any dispute over a claim, the decision of the Manufacturer is final and binding. In addition to the foregoing the Manufacturer's standard terms of business shall apply.
This Guarantee shall be construed and interpreted in accordance with English law and shall be subject to the jurisdiction of English courts only.
The Guarantee does not affect the statutory rights of consumers.

Dec 2021



Billet Lane,
Normanby Enterprise Park,
Normanby Road,
Scunthorpe,
North Lincolnshire
DN15 9YH

01724 848500
sales@dekboard.co.uk

dekboard.co.uk

DekBoard Foiled Product Guarantee



DekBoard Foiled Product Guarantee

This **DekBoard** (the Manufacturer) **Foiled Product Guarantee** (the Guarantee) is only available for DekBoard Foiled PVC profiles and fittings.



10 Year Guarantee as standard

The guarantee covers DekBoard's Foiled PVC products (the Products) used on the installation. This document is not an installation guarantee and therefore does not cover any aspect of the installation of the products.

The manufacturer guarantees the foiled products from the date of purchase subject to the terms and conditions.



Foiled PVC profiles and fittings 10 year guarantee

Terms and Conditions

- Products covered by this Guarantee**
 - This guarantee applies to foiled PVC profiles and fittings within the woodgrain range of foiled products manufactured by DekBoard. All other foiled profiles and fittings are excluded from this Guarantee.
 - This Guarantee applies only to products sold and fitted within the UK and the Republic of Ireland. Any products purchased or fitted in another jurisdiction are excluded from this Guarantee.
 - Products which are not covered by this Guarantee may be subject to a separate guarantee.
- Duration of this Guarantee**
This Guarantee will remain in force for 10 years from the date of installation of the products.
- Cover provided under this Guarantee**
 - DekBoard guarantees that, for the duration of this Guarantee, but subject to the other provisions of this Guarantee:
 - the profiles and fittings will not warp or crack;
 - exposure to normal weathering will not result in any significant part of the woodgrain foiled profiles or fittings changing colour compared to DekBoard's relevant colour specification by more than grey scale 3 (where grey scale is determined in accordance with ISO105-A02). This paragraph (ii) does not cover any change resulting from any form of shading (such as any overhang or any obstruction of the sun by any permanent or temporary structure or trees);
 - exposure to normal weathering will not result in any shrinking or delamination of the woodgrain foil from the profile to which it is adhered.
 - In the case of a valid claim under this Guarantee, DekBoard will, at its absolute discretion, either repair or replace the defective profiles and fittings. This Guarantee does not cover any labour costs incurred by the Customer or any third party in installing the repaired or replacement profiles and fittings.
- Exclusions**
 - This Guarantee will not apply if:
 - the profiles or fittings have not been stored, installed and maintained in accordance with DekBoard's recommended fitting details and maintenance procedures;
 - the profiles and fittings have not been used in accordance with DekBoard's instructions;
 - the profiles or fittings have been coated or had any other process or repair performed on them other than by DekBoard;
 - the defect is caused by willful or accidental damage, vandalism or negligence (other than that of DekBoard or its sub-contractors);
 - the profiles and fittings have been stored and/or permanently installed
 - in climate zones where the ambient temperature regularly falls outside the range +40°C to -10°C, or
 - at elevations above 1800 metres above sea level;
 - the profiles and fittings have been exposed, in storage or end use, to atmospheric pollution, acid rain, harmful chemicals or vapours, fire, lightning, flood, abnormal winds or earthquakes, or the effects of external heat sources or reflective surfaces, or undue wear and tear, or other unusual conditions; or
 - the profiles or fittings have been moved from the site where the defect is alleged to have occurred.
 - the profiles or fittings have been washed with anything other than warm water and mild detergent.
 - if profiles or fittings have been scrubbed with abrasive papers such as sandpaper etc. Please be aware that some brands of sunscreen can permanently stain foiled balustrade finishes.
 - if any jet washers are used on the foiled profile or fittings.
 - if any hot surface such as barbecues or similar is near or close contact to any foiled profile or fitting.
 - if solvent adhesive or superglues are used with any foil surfaces.
- Transfer of this Guarantee & How to Make a Claim**
 - This Guarantee is for the benefit of the Customer and only applies if proof of purchase can be provided. Proof of purchase must detail the relevant property address.
 - Any unexpired part of the life of this Guarantee may be transferred to subsequent owners of the Property.
 - This Guarantee along with the receipt shall be retained by the customer to demonstrate proof of purchase. DekBoard reserves the right to refuse any claim under a Guarantee where the customer cannot provide the original Guarantee document and the receipt.
 - To make a claim under this Guarantee, please contact DekBoard on 01724 848 500.
- Your rights**
This Guarantee does not affect any rights the Customer has in law relating to the quality of the guaranteed products. For further information about your legal rights contact your local Trading Standards Department or Citizens Advice Bureau.



Billet Lane,
Normanby Enterprise Park,
Normanby Road,
Scunthorpe,
North Lincolnshire
DN15 9YH

01724 848500
sales@dekboard.co.uk

dekboard.co.uk

Feb 2021



Guarantee - 10 Year Performance

We are so confident about the quality of DekBoard that we guarantee its structural performance for 10 years. DekBoard is made in the UK under strict quality, environmental and health and safety management systems. All our decking boards are regularly checked for size, shape and the quality of the finish. They are also tested for fire resistance, slip resistance, wear resistance and load carrying capacity.

About DekBoard

DekBoard are part of Specialist Building Products Ltd, owned by Epwin Group PLC. We have 40 years' manufacturing experience across 3 factories, and 20 years' experience in the manufacture of PVC and composite decking.

The manufacturing site of DekBoard is conveniently placed centrally in the UK, employs around 300 people and typically extrudes around 1 million linear metres of PVC building products each year across over 9,000 unique product codes. We live by the following values:

- Environment
- Circular Manufacturing
- Quality Management
- Customer Care



DEKBOARD®

Billet Lane
Normanby Enterprise Park
Normanby Road
Scunthorpe
North Lincolnshire
DN15 9YH

01724 848500
sales@dekboard.co.uk



dekboard.co.uk

